



*Qual-Tech Engineers, Inc.*

## *Harmonic Considerations on Low Voltage Systems*

– *By* –

*W. Edward Reid, et al*

Copyright © 1991 IEEE

Reprinted (with permissions) from the Proceedings of the  
IEEE 1991 Annual Textile, Fiber and Film Industry Technical Conference  
(IEEE Catalog Number 91 CH 2999-1)

This material is posted here with permission of the IEEE. Such permission of the IEEE does not in any way imply IEEE endorsement of any of Qual-Tech Engineers' products or services. Internal or personal use of this material is permitted. However, permission to reprint/republish this material for advertising or promotional purposes or for creating new collective works for resale or redistribution must be obtained from the IEEE by writing to [pubs-permissions@ieee.org](mailto:pubs-permissions@ieee.org).

By choosing to view this document, you agree to all provisions of the copyright laws protecting it.

*Qual-Tech Engineers, Inc.*  
201 Johnson Road  
Building #1 · Suite 203  
Houston, PA 15342-1300  
724-873-9275  
FAX 724-873-8910  
[www.QualTechEng.com](http://www.QualTechEng.com)

# HARMONIC CONSIDERATIONS ON LOW VOLTAGE SYSTEMS

PAUL B. STECIUK

KEVIN A. PUSKARICH

W. EDWARD REID

Qual-Tech Engineers, Inc.  
110 Fort Couch Road  
Pittsburgh, Pa. 15241

Copyright 1991 IEEE. Reprinted, with permission, from Proceedings of IEEE 1991 Textile, Fiber, and Film Industry Technical Conference.

**Abstract** - The continually increasing use of harmonic producing loads and capacitors throughout industrial power systems has resulted in an increased awareness of the harmonic considerations associated with these applications. This paper discusses this topic from a systems point of view for low voltage applications, emphasizing the system interaction effects and the means that can be used to minimize this interaction. Guidelines are included for the proper application of harmonic producing loads and capacitors.

Therefore, the zero sequence problems discussed for single phase loads above is not a factor here.) Examples of such devices are variable speed and variable frequency ac drives, dc drives, three phase power controlled furnaces, UPS systems, dc chemical processes, welders, and many other types of equipment.

## INTRODUCTION

Over the past decade there has been a significant increase in the use of shunt capacitors and harmonic producing loads on low voltage systems (up to 1000volts). When used properly, this combination of capacitors and harmonic producing devices can result in a significant increase in the efficiency of the operation of the electrical system. When they are not used properly, harmonic distortion can become excessive and this can negatively affect the operation of the facility.[1 to 5] On low voltage systems, the standards have recommended a voltage distortion limit of 5% with a 3% maximum for sensitive loads such as hospitals and airports.[6,7] When these limits are met, problems rarely occur. In this paper guidelines are provided for controlling distortion while still using harmonic producing loads and capacitors.

### Single Phase Harmonic Producing Loads

Single phase devices generally exhibit the following harmonics of the fundamental in the current waveform: 3, 5, 7, 9, 11, 13, etc. (This includes all of the odd harmonics.) Examples of such devices are a personal computer in an office, a power controlled furnace in an industrial application, a single phase welder, fluorescent lighting, electronic ballasts, and a myriad of other equipment.

The harmonic content of such devices is generally highest at the third harmonic and continually decreases as the harmonic number increases. Example harmonic currents for such devices are given in Table 1. (These values are examples. They do vary even among similar devices.) When a high percentage of the load is composed of these types of devices, one of the biggest concerns is the high zero sequence current that flows in the neutral.[8] Even when the loads are balanced, the neutral current can be on the order of two times the phase current. Under these conditions, the neutral current is primarily composed of the 3rd harmonic and to a much lesser extent the 9th, 15th, etc.

Generally, a delta-wye grounded transformer is used to supply these types of loads and this transformer connection keeps the zero sequence harmonic currents from flowing into the high voltage system. On the low voltage side this type of problem is generally addressed by over sizing the neutral and rating the supplying transformer to handle the harmonic duty. The application of filters at these loads is generally expensive and, consequently, is rarely done.

### Three Phase Harmonic Producing Loads

At low voltages most three phase harmonic producing devices are 6-pulse and, therefore, exhibit the following harmonics: 5, 7, 11, 13, 17, 19, etc. (This includes all of the odd harmonics, except for multiples of three.

Table 1  
Example Harmonic Currents  
for Single Phase Devices

Harmonic	Arc Welder	Personal Computer	Flourescent Lights
1	100.0%	100.0%	100.0%
3	29.6%	75.0%	12.3%
5	8.8%	47.3%	13.8%
7	2.0%	22.9%	3.0%
9	2.3%	9.0%	1.1%
11	2.3%	3.3%	0.7%
13	1.1%	3.0%	0.5%
15	0.4%	2.1%	
17	0.9%	1.9%	

Table 2  
Example Harmonic Currents  
for Three Phase Devices

Harm.	Induction Furnace	DC Motor*	DC Furnace	PWM Drive**	Load Comm. Inverter Drive
1	100.0%	100.0%	100.0%	100.0%	100.0%
5	20.9%	31.7%	18.9%	25.0%	21.6%
7	12.7%	1.1%	10.3%	11.0%	12.6%
11	7.8%	8.6%	5.4%	7.5%	8.7%
13	7.2%	2.5%	3.9%	5.0%	6.5%
17	4.3%	4.7%	1.8%	4.4%	5.2%
19	4.9%	2.3%	1.3%	3.2%	4.2%
23	2.6%	3.1%	0.6%	2.6%	3.4%
25	3.6%	2.1%	0.5%	2.0%	2.9%
29	1.7%	2.2%	0.5%	1.7%	2.4%
31	2.7%	1.9%	0.5%	1.3%	2.1%
35	1.2%	1.7%	0.4%	1.0%	1.7%
37	2.0%	1.8%	0.4%	0.8%	1.3%
41	0.8%	1.4%	0.3%	0.6%	1.1%
43	1.4%	1.6%	0.3%	0.5%	0.8%
47	0.5%	1.1%	0.2%	0.4%	0.7%
49	1.0%	1.3%	0.2%	0.3%	0.5%

\* Dc motor was operated phased back and at low power factor.

\*\*This PWM drive had a dc choke. Without the choke the % Current at the 5th, 7th, 11th, and 13th would be much higher.

The harmonic content of such devices is generally highest at the fifth harmonic and continually decreases as the harmonic number increases. Example harmonic currents for such devices are given in Table 2 for operation near full load. When the harmonic content on the system is excessive, some of the common problems that occur are overheating of transformers, overheating of motors, unexplained fuse blowings or breaker trips, misoperation of electronic devices, and other similar problems. Excessive distortion for these types of loads can generally be controlled by using higher pulse number devices or adding filter banks to the system.

### Other Types of Harmonic Producing Loads

The vast majority of the harmonic producing loads on low voltage systems fall into the two categories described above, but there are other types of harmonic producing loads. Among the next most common are 12-pulse and 3-pulse loads. At low voltage, 12-pulse is relatively rare, although examples could include UPS systems and sensitive welding operations. From a harmonic point of view, 12-pulse reduces the distortion compared to the devices discussed above. 3-pulse is also relatively rare. It exhibits dc and even harmonic characteristics, including the 2nd and the 4th. The dc component can cause transformer saturation and the high harmonic content can cause significant heating. Consequently, 3-pulse devices are seldom used at high kVA ratings and should be avoided.

### Low Voltage Capacitors

Low voltage capacitors are basically applied in three different ways:

- Distributed at the individual loads, especially induction motors,
- Fixed at the main bus,
- Switched at the main bus.

The most effective location and the need for switching is based on the cost and the associated benefit of each option in a given application. The harmonic implications are discussed in the following sections of this paper.

### System Configuration

Figure 1 illustrates a simplified one line diagram of a typical industrial plant consisting of a mixture of linear and nonlinear loads with a capacitor bank used for power factor correction. This example system is general enough to apply to a very high percentage of the low voltage systems which are in service and is the basis for the derivation of the guidelines determined in this paper. The key factors associated with this example system are summarized as follows:

The nonlinear loads are six pulse converters with the typical harmonic characteristic given in Table 3. (In actuality, the currents can vary from these values, but this table is reasonable to use for this evaluation.)

For plants that contain many drives that operate at random speeds and operating conditions, it is reasonable to determine the harmonic content of all the drives by taking the square root of the sum of the squares of the individual drive KVA values and then determining the harmonic content per the values in Table 3. This method should be applied with discretion since it decreases the total harmonic current injection and can yield optimistic results.

The X/R of the impedance at the Main Bus is largely determined by the transformer X/R and is considered to be constant with frequency. For industrial plants ranging from 1500 KVA to 3000 KVA with 480 to 600 volt secondaries, an X/R ratio of 8.0 is typical. For this reason, an X/R ratio of 8.0 is used in the evaluation in this paper.

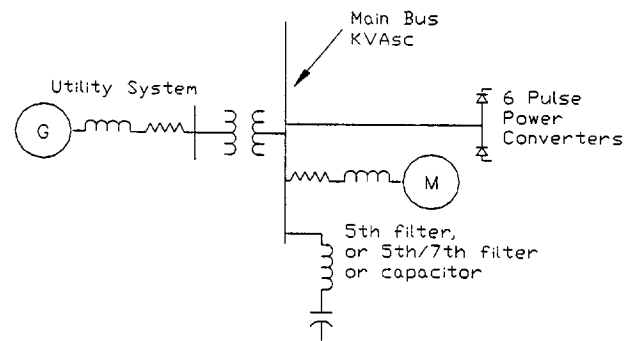

Fig. 1 Typical Industrial Plant

Table 3  
Harmonic Currents  
for Developing Guidelines

Harmonic	Harmonic Current (%)
1	100.0%
5	20.0%
7	12.0%
11	8.0%
13	7.0%
17	4.5%
19	4.0%
23	3.0%
25	3.0%

In most cases, capacitors are usually applied to an industrial system to reduce a power factor tariff imposed by the utility or to release system capacity. In either case a predetermined amount of kvar is determined without regard to harmonics. In the following pages a step by step procedure is outlined that will facilitate the plant engineer in predicting the total harmonic voltage distortion (V<sub>thd</sub>) when the addition of capacitors or variable speed drives is planned. In situations where the V<sub>thd</sub> is over the IEEE recommended limit of 5% a minimum harmonic filter design can be determined.

Figure 2 is the equivalent circuit for making harmonic calculations for the industrial plant illustrated in Figure 1. The six pulse power converters are treated as constant current sources and are modeled using the values in Table 1. The motor, capacitor, and system impedance are modeled as linear impedances which vary with frequency. Calculating the harmonic currents and voltages throughout the system is simply a matter of  $V = I \times Z$  for a wide range of system conditions.

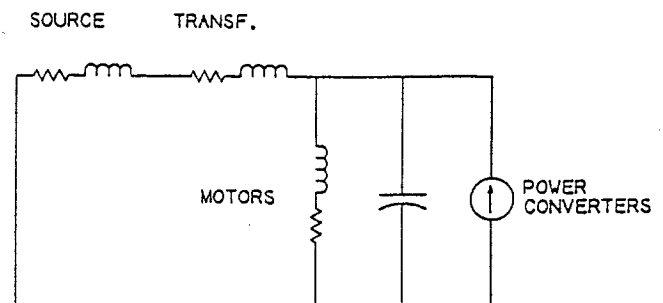

Fig. 2 Equivalent Circuit for Harmonic Calculations

### HARMONIC DISTORTION WITHOUT CAPACITORS

Since the harmonic currents are considered as a constant percentage of the total drive current, an equation relating  $V_{thd}$  to the drive kVA ( $KVA_{6p}$ ) and the short circuit duty ( $KVAsc$ ) can easily be developed. The  $V_{thd}$  without capacitors or filters on the system illustrated in Figure 1 can be determined by the following equation, based on the harmonic current values given in Table 3:

$$\%V_{thd} = 2.35 \times (KVA_{6p}/KVAsc) \times 100\% \quad (1)$$

The plot of this equation is shown in Figure 3. It is apparent that a  $KVAsc/KVA_{6p}$  ratio of less than 47 will result in a  $V_{thd}$  of greater than 5%. For a typical 2000 kVA transformer with a 1% system impedance and 5.75% transformer impedance, this equates to approximately 30% of the total transformer load consisting of 6-pulse power converters. If the  $KVAsc/KVA_{6p}$  is less than 47, it is recommended that filters be applied to minimize voltage distortion and risk of equipment damage.

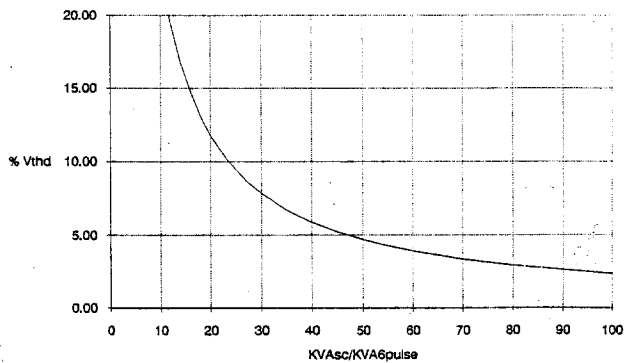

Fig. 3 %Vthd vs. KVAsc/KVA6pulse

### HARMONIC DISTORTION WITH CAPACITORS

The application of power factor correction capacitors to the system in Figure 1 may cause the  $V_{thd}$  to increase. This is due to the formation of resonance between the capacitor bank and the system impedance. Figure 4 illustrates an impedance scan of an industrial plant viewed from the drive which shows a high impedance near the seventh harmonic due to the addition of the capacitor bank. When no capacitors are energized on the power system, a purely inductive impedance is seen. The resonance causes an increase in impedance and, therefore, the injected current from the 6-pulse drives causes an increase in the harmonic voltage. The harmonic at which the resonance occurs can be determined by the following equation:

$$h = \sqrt{KVAsc/kvar} \quad (2)$$

In general, if "h" is determined to be close to one of the harmonic currents listed in Table 3, significant harmonic distortion can occur. In Figure 5, the maximum  $V_{thd}$  is plotted for the example system for the condition where "h" is near any of the frequencies listed in Table 3. From Figure 5 it is evident that if  $KVAsc/KVA_{6p}$  is less than 175 and capacitors are applied on the system,  $V_{thd}$  may exceed 5%. For a typical 2000 kVA transformer with a 1% system impedance and 5.75% transformer impedance, this equates to approximately 10% of the total transformer load consisting of 6-pulse power converters. In power systems containing many small drives operating at different phase angles, the total higher order harmonic currents will be less than the values shown in Tables 1 and 2 and therefore the  $V_{thd}$  predicted by Figure 5 will also be less. When multi-step

switched capacitor banks are used, the resonant frequency will decrease as steps come on. If the 6-pulse load is greater than 10% of the total, it is possible that resonance and high distortion will occur at one or more of the capacitor bank values.

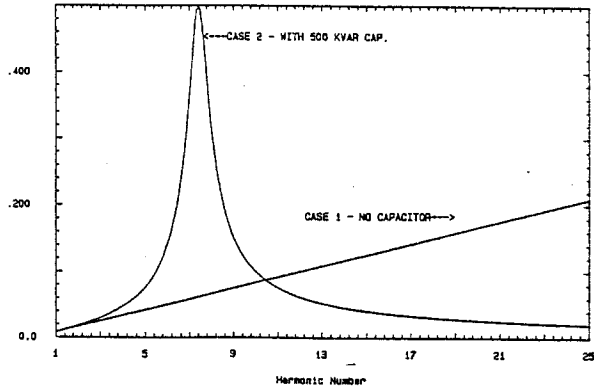

Fig. 4 System Impedance Scan vs. Harmonic Number

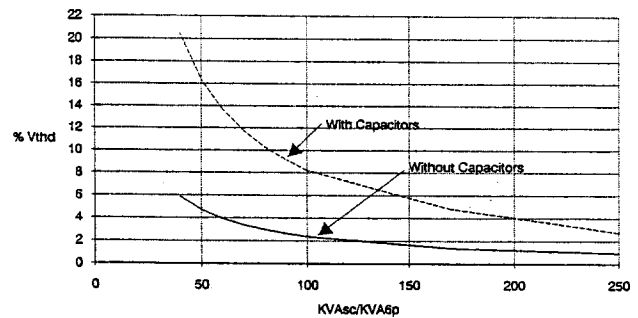

Fig. 5 Maximum %Vthd vs. KVAsc/KVA6p

### HARMONIC DISTORTION WITH FILTERS

If voltage distortion is determined to be a problem, a filter may be applied to the system. Figure 6 illustrates how a 5th harmonic filter reduces the system impedance near the 5th harmonic; this will in turn reduce the voltage distortion. A minimum filter size can be determined from Figure 7 to limit the voltage distortion on the main bus to 5%. Figure 7 shows four curves; two curves for filters applied at the main bus and two corresponding to filters applied on the secondary of an isolation transformer or a series reactor with 5.75% impedance serving a large drive or group of drives. The kvar size of the filters on the secondary side of the isolation transformer are smaller, but isolation transformers are not always used. The kvar size of the 5th/7th filter is smaller, but it requires an additional set of reactors and, therefore, may be more expensive. The specific filter design is usually determined by both system requirements and economics. If the filter requirements are less than the power factor requirements, a larger filter can be applied.

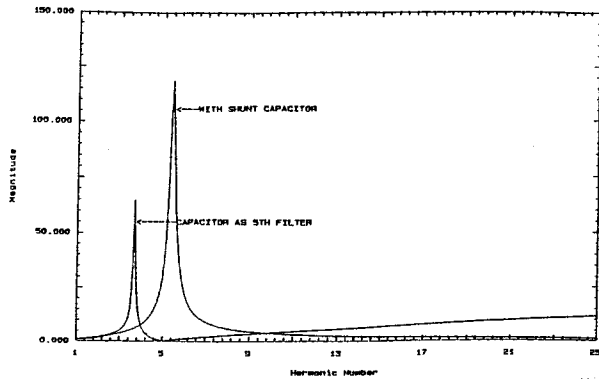

Fig. 6 System Impedance Scan vs. Harmonic Number

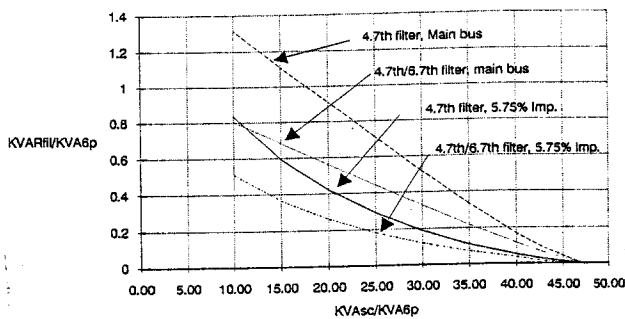

Fig. 7 Minimum Filter Design

The addition of a reactor in series with the capacitor bank causes the fundamental frequency voltage to rise on the capacitor above the main bus voltage. This voltage can be determined by the following equation:

$$\% \text{Voltage} = \left( \frac{N^2}{N^2 - 1} \right) \times 100\% \quad (3)$$

where N is the tuned frequency of the filter

For example, a filter tuned to N = 4.7 would have a 60Hz capacitor voltage of 4.7% above the main bus voltage. Also the harmonic currents drawn by the capacitor and reactor combination causes a harmonic voltage to appear across the capacitor. For these two reasons, capacitors applied as filters are overrated in voltage. Figures 8a and 8b illustrate the peak voltage on the capacitors in % of the nominal system voltage for the minimum filter sizes given in Figure 7. For 480 volt systems, this commonly results in using standard 600 volt capacitors.

Figures 9a and 9b illustrate the harmonic current duties seen by the reactor and the capacitor for the minimum recommended filter sizes. The currents are given in % of the filter 60 Hz current.

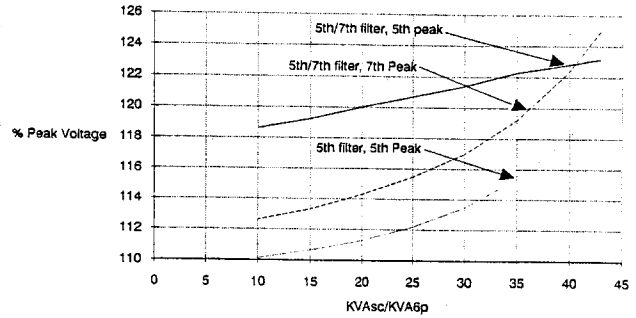

(a) Filter Bank at Main Bus

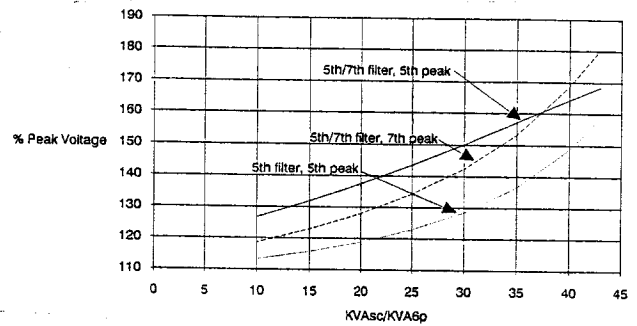

(b) Filter Bank at Isolation Transformer  
Fig. 8 Capacitor Voltage Duty for Minimum Filter Design

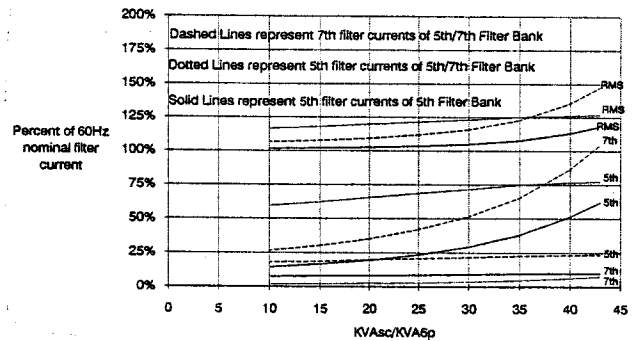

(a) Filter Bank at Main Bus

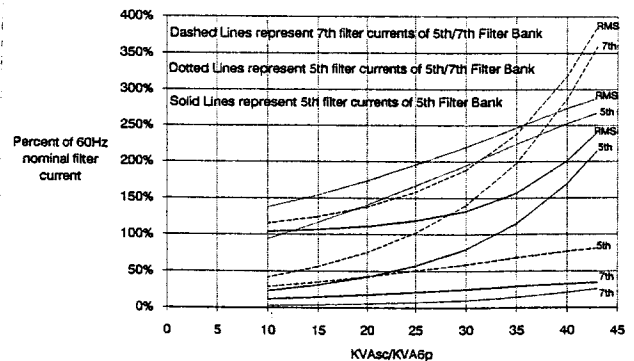

(b) Filter Bank at Isolation Transformer  
Fig. 9 Inductor Current Duty for Minimum Filter Design

Figures 7, 8, and 9 give guidance on the minimum filter size, and the associated voltage and current ratings required. (If filters larger than the minimum are chosen, the percent voltage and current duties will be lower than given in the curves.) These will allow a filter size to be approximated for a given application. However, in choosing a final filter design, it is important to consider all of the following parameters.

**Filter tuning.** If 5th and 7th filters are appropriate, the filter tuning is usually near the 5th and 7th. The nominal filter branch tuning for a given application can vary and need not be exactly at 4.7 or 6.7 as is used in this paper.

**Capacitor and reactor tolerances.** The appropriate equipment tolerances need to be determined so that the filter will perform as required. Wide tolerances on capacitance and inductance can result in a filter not operating as expected. In some cases it may be appropriate to have reactor taps or small capacitor units available for fine tuning the filter.

**Harmonic current spectrum.** The harmonic current spectrum is important to assure that reactor heating and vibration have been properly accounted for in the design. If an iron core reactor is used, its operating flux must be designed sufficiently high to handle the rated continuous current as well as the short term overloads without saturating.

**Unbalance Detection.** Since capacitors may fail and fuses blow, it is essential to have a method to detect this condition and to take the appropriate action, such as deenergizing the capacitor bank. The partial loss of capacitors in a bank will change its tuned frequency and possibly increase the filter duty and the system distortion level.

**Parallel Resonances.** When a 5th harmonic filter is applied, a parallel resonant frequency typically occurs in the area of the 3rd to the 4th harmonic. (See Figure 6.) To avoid possible transient voltages resulting from transformer energization, it is advisable to avoid this point falling on the third harmonic. [8] The transient due to a 4th harmonic parallel resonance may also occur, but it is much less significant than the third. This potential problem can be avoided by energizing transformer with the filter disconnected from the system. As long as the capacitor switching device opens on loss of voltage and does not close until system voltage is restored, this potential condition will be eliminated in the vast majority of cases.

### GUIDELINES

In Table 4 a brief summary is given of the key guidelines developed in this paper. It should be noted that these guidelines have been derived for certain system conditions which are fairly common. However, there are conditions that fall outside of these guidelines as summarized below:

Capacitors on the medium and high voltage systems may have a significant influence on the distortion levels. However, when the ratio of the transformer impedance in % to the system impedance in % is greater than four, the medium and high voltage capacitors tend to have a small effect. If that ratio is less than four, consideration should be given to the status of any such capacitors in the system analysis. The guidelines given in this paper can form a starting point, but additional analysis must be done to determine the final solution.

When large non-linear loads are served by utility distribution systems and electric power lines parallel telephone lines, it is possible to have telephone interference. This is a relatively rare condition and it is not covered by the above guidelines.

Harmonics sources from other locations on the power system may

cause significant distortion at another low voltage location. This is more likely to occur if the natural frequency of the system and the capacitor are in the range of the 5th to the 7th harmonics. If large concentrations of harmonic producing loads are nearby, it is good to apply capacitors and avoid the area of the 5th to the 7th even if there are no harmonic producing loads on that transformer.

It is usually difficult to apply filter banks and non-filter capacitor banks on the same bus and avoid resonance problems. If this appears to be viable in a given application, a detailed study should be done to assure a proper application.

It should be noted that it is possible to make measurements on an existing system to determine if capacitors, which are about to be added, should be applied as filters or not. From the measurements one can estimate the equivalent harmonic load and use the guidelines accordingly.

**Table 4**  
**Summary of Guidelines**

System Configuration *	KVAsc/KVA6p	%Vthd	Conclusion/ Recommendation
No Capacitors	> 45	< 5	No problem
No Capacitors	< 45	> 5	Add filter, see Fig. 7
Cap., multiple drives	> 175	< 5	No problem
Cap., multiple drives	< 175, and h < 26	likely > 5	Add filter/perform system analysis
Capacitors, 1 drive	< 175	likely > 5	Add filter/perform system analysis
Capacitors, 1 drive	> 175	< 5	No problem

\* Table based on Figure 1

### EXAMPLE PROBLEM

An example system is illustrated at the top of Figure 11. To use the guidelines which have been developed in this paper, the key information summarized from this one line is given as follows:

$$\text{KVAsc at 480 volt bus} = 27,750 \text{ (based on one line diagram)}$$

$$\text{KVA6p} = 750$$

A 500 kvar capacitor is required at the main bus to meet the power factor requirements.

Based on this information:

1.  $\text{KVAsc/KVA6p} = 27,750/750 = 37$

From Figure 3, without capacitors the voltage distortion would be approximately 6.4%.

2. With the 500 kvar capacitor bank, the system resonant frequency would be at approximately  $h = 7.4$ . (See equation (2).) This is very close to the seventh harmonic and could be a problem. From Figure 5, the voltage distortion could be greater than 20% for this condition.

- Referring to Figure 7, for  $KVAsc/KVA6p$ , the ratio of  $KVARfil/KVA6p$  for a 4.7th filter is approximately .27. This means that the minimum size of the 4.7th filter to meet the 5% distortion limit would be  $.27 \times 750 = 203$  kvar. Since we are adding a 500 kvar capacitor, it can be applied as a 4.7th filter and it will meet both the power factor and the distortion requirements.

A detailed simulation of this system was carried out. It is discussed as follows:

- The impedance scans for the three system conditions are illustrated in Figure 10. With the 500 kvar capacitor in service (case 2), the resonant frequency of the system is near  $h = 7.4$  as calculated above. The scans also illustrate how applying the capacitor as a filter moves the resonant frequency to below the 5th harmonic where there are no significant harmonics in this example.
- Detailed waveforms for cases 1, 2, and 3 are given in Figures 11, 12, and 13 respectively. A tabulation of the key values is given in Table 4.

- When the 500 kvar capacitor bank is added, the voltage distortion at the 480 volt bus goes from 5.7% to 17.1%. When the capacitor is applied as a filter, the voltage distortion is reduced to 3.3%.

- For the resonance condition, other items that should be noted are:

The 7th harmonic current in the capacitor is at 117% of the fundamental. (Concern is for fuse blowing and breaker tripping.)

Harmonic current in the motor is at 19%. (Concern is for motor overheating.)

The transformer current distortion is at 35% at full load current. (Transformer standards allow a maximum of 5% harmonic current.)

The power factor is only at 86% (due to distortion) compared to the expected value of 94% with the capacitor in service.

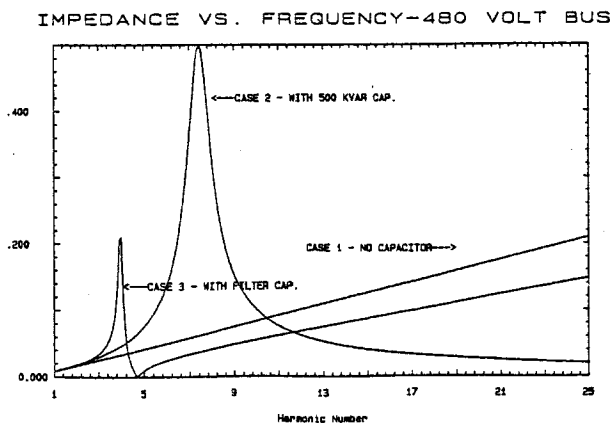
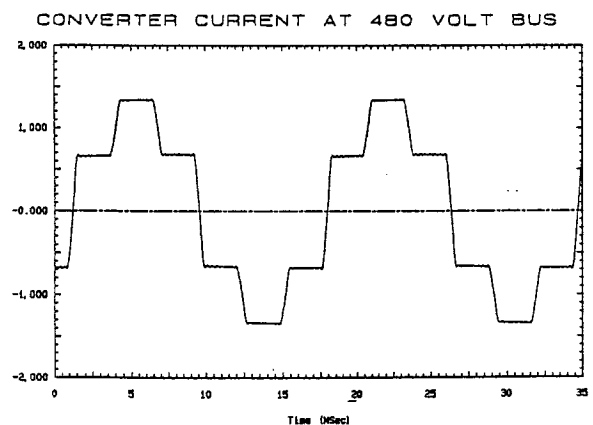
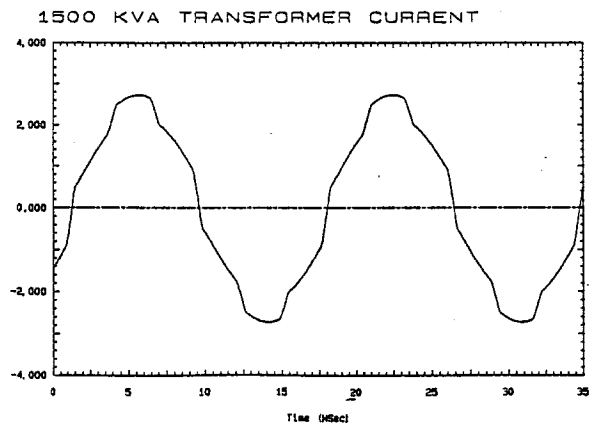
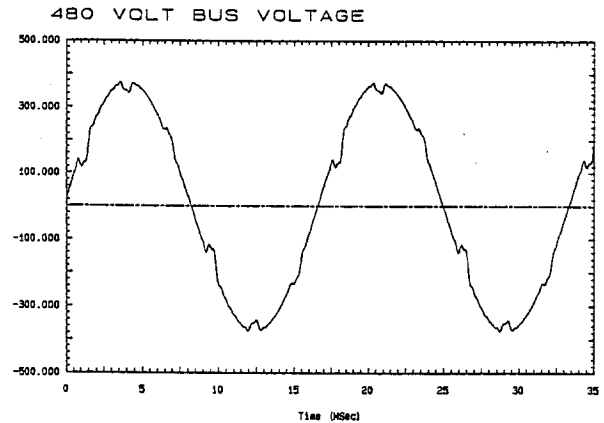
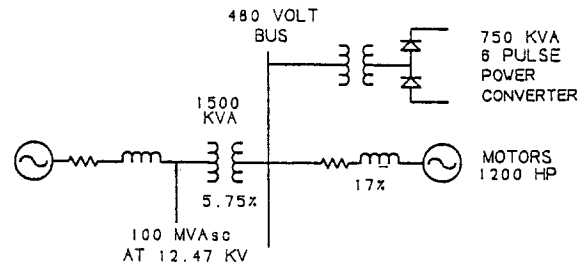

Fig. 10 Impedance Scans

Fig. 11 Example - Case 1

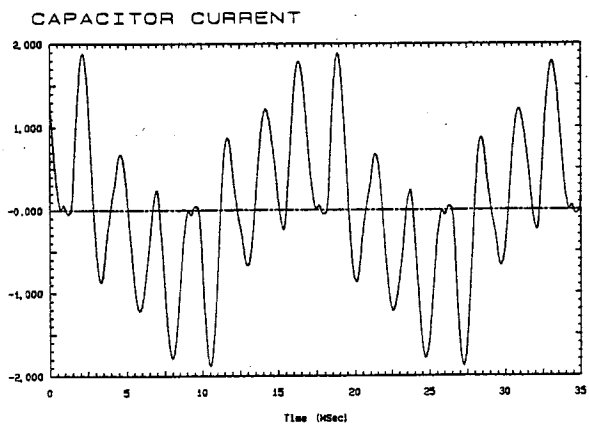
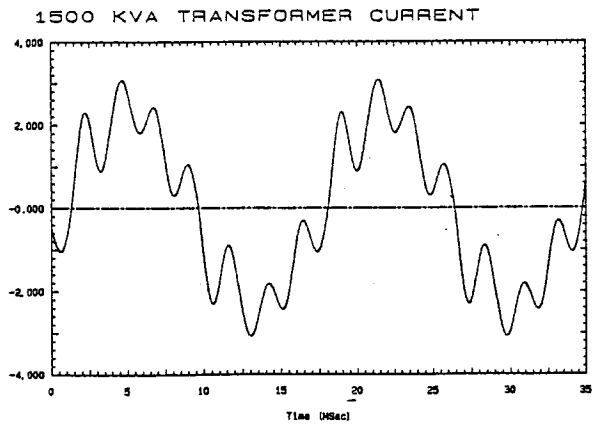
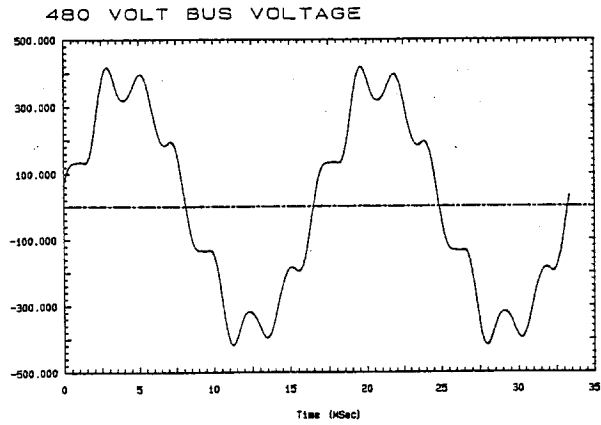
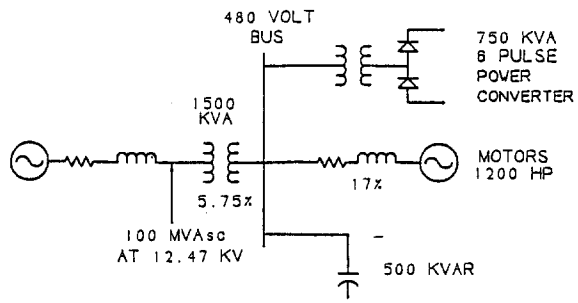

Fig. 12 Example - Case 2

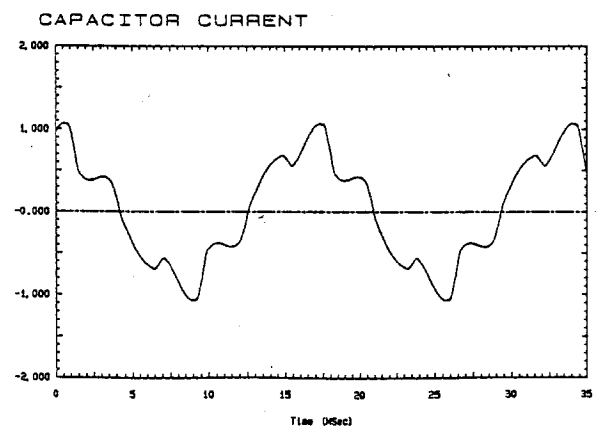
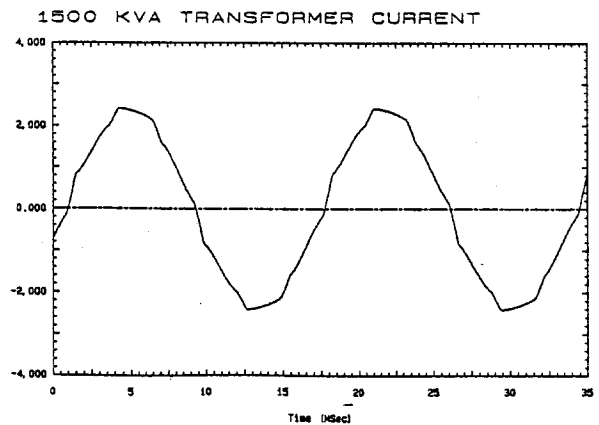
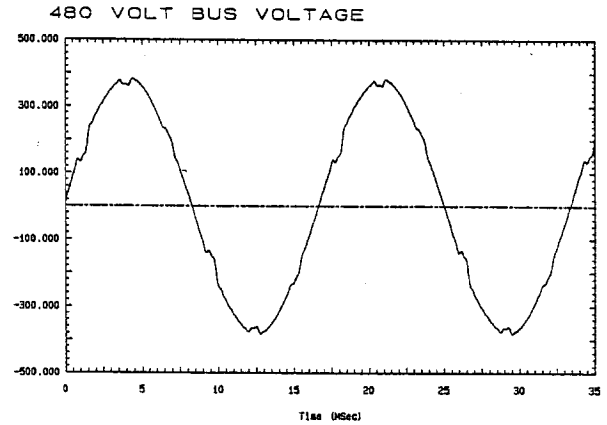
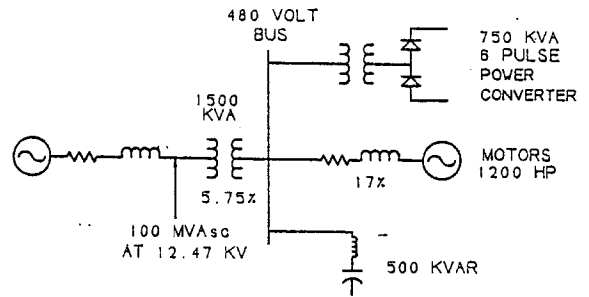

Fig. 13 Example - Case 3



## SUMMARY AND CONCLUSIONS

Table 4  
Summary of Results of Three Example Cases

Case	480 Volt Bus		
	% Vthd	Highest Harmonic	
		Number	%
1 - No Capacitor	5.69%	5	2.76%
2 - 500 KVAR Capacitor	17.14%	7	16.27%
3 - 500 KVAR Filter Cap.	3.28%	11	1.53%

Case	12.47 KV Bus		
	% Vthd	Highest Harmonic	
		Number	%
1 - No Capacitor	1.11%	5	0.54%
2 - 500 KVAR Capacitor	3.39%	7	3.22%
3 - 500 KVAR Filter Cap.	0.65%	7, 11	0.30%

Case	Motor Current				
	Tot. RMS (Amps)	I1 RMS (Amps)	% Ithd	Highest Harmonic	
				Number	%
1 - No Capacitor	985	983	5.99%	5	4.51%
2 - 500 KVAR Capacitor	1087	1067	19.40%	7	17.82%
3 - 500 KVAR Filter Cap.	1071	1071	2.43%	7	1.64%

Case	Capacitor Current				
	Tot. RMS (Amps)	I1 RMS (Amps)	% Ithd	Highest Harmonic	
				Number	%
1 - No Capacitor	-	-	-	-	-
2 - 500 KVAR Capacitor	901	578	119.35%	7	113.89%
3 - 500 KVAR Filter Cap.	623	606	23.97%	5	21.97%

Case	1500 KVA Transformer Current				
	Tot. RMS (Amps)	I1 RMS (Amps)	% Ithd	Highest Harmonic	
				Number	%
1 - No Capacitor	1900	1892	8.99%	5	6.77%
2 - 500 KVAR Capacitor	1795	1692	35.34%	7	32.46%
3 - 500 KVAR Filter Cap.	1687	1685	4.47%	7	3.01%

Case	Total Load			
	KVA = $V_{rms} \times I_{rms}$	Power Factor	KVA1 = $V1 \times I1$	
			KVA1	Power Factor
1 - No Capacitor	1494	0.839	1486	0.845
2 - 500 KVAR Capacitor	1486	0.864	1353	0.940
3 - 500 KVAR Filter Cap.	1351	0.942	1349	0.944

In this paper guidelines have been developed for applying capacitors and harmonic producing loads on low voltage systems. A detailed example is included to illustrate the details. These guidelines are applicable for a high percentage of low voltage applications.

There are also conditions that can fall outside of these guidelines, for example, if there are capacitors or large harmonic producing loads on the nearby utility system.

When equipment is applied properly, power factor correction and distortion control can both be achieved.

## REFERENCES

1. W.E. Reid and K.J. Petrus, "Harmonics and Capacitors in the Power System", presented at the Pacific Coast Electrical Association Engineering & Operating Conference, Los Angeles, California, March 19-20, 1985.
2. W.S. Vilcheck and D.A. Gonzalez, "Guidelines for Applying Shunt Capacitors on Industrial Power Systems", presented at the Industrial & Commercial Power Systems Conference, Denver, Colorado, May 13-16, 1985.
3. D.A. Gonzalez and J.C. McCall, "Design of Filters to Reduce Harmonic Distortion in Industrial Power Systems", Industry Application Society's Annual Meeting, October 1985.
4. R.A. Adams, R.C. Catoe, J.G. Dalton, and S.G. Whisenant, "Power Quality Within Modern Industrial Facilities", IAS Textile, Fibre, and Film Industry Conference, May 1990.
5. W.E. Reid, "Capacitor Application Considerations-Utility/User Interface". IAS Pulp and Paper Industry Technical Conference, June 1991.
6. IEEE Guide for Harmonic Control and Reactive Compensation of Static Power Converters, IEEE Standard 519-1981, New York, 1981
7. C.K. Duffey and R.P. Stratford, "Update of Harmonic Standard IEEE-519, IEEE Recommended Practices and Requirements for Harmonic Control in Electric Power Systems", IEEE Paper No. PCIC-88-7.
8. Arthur Freund, "Double the Neutral and Derate the Transformer or Else!", EC&M, December 1988.