

Harmonic Experience with a Large Load Commutated Inverter Drive

– By –

W. Edward Reid, et al

Copyright © 1991 IEEE

Reprinted from the Conference Record of the
1999 Annual Petroleum and Chemical Industry Technical Conference
(Paper 99-18)
Also published in the IEEE Transactions on Industry Applications,
Vol. 37, No. 1 January/February 2001

This material is posted here with permission of the IEEE. Such permission of the IEEE does not in any way imply IEEE endorsement of any of Qual-Tech Engineers' products or services. Internal or personal use of this material is permitted. However, permission to reprint/republish this material for advertising or promotional purposes or for creating new collective works for resale or redistribution must be obtained from the IEEE by writing to pubs-permissions@ieee.org.

By choosing to view this document, you agree to all provisions of the copyright laws protecting it.

Harmonic Experiences with a Large Load-Commutated Inverter Drive

Kevin A. Puskarich, W. Edward Reid, *Member, IEEE*, and Paul S. Hamer, *Fellow, IEEE*

Abstract—This paper illustrates the use of a high-pass filter for reducing troublesome harmonic distortion caused by a large load-commutated inverter drive at a large petrochemical plant. Actual field measurement data of the 12.47-kV distribution system of the plant is given to show the harmonic distortion that was causing operational problems. The harmonic system impedance derived from these measurements was used in the development of an accurate harmonic analysis computer model. This harmonic model was then used to evaluate the application of a high-pass filter to reduce harmonic distortion. Actual field measurements were then made after the installation of the high-pass filter to verify the results of the simulations. The tools used for this paper included a harmonic analyzer, an oscilloscope, a harmonic simulation program, and an electromagnetic transient simulation program. The results of this investigation lead to proposed improvements to IEEE Std 519.

Index Terms—Harmonic measurements and analysis, high-pass harmonic filter, load-commutated inverter drive.

I. INTRODUCTION

A MAJOR oil company has installed a large load-commutated inverter (LCI) drive at each of three refineries. At each location the total voltage distortion was less than 3% prior to the installation of the drive. With the operation of the drive, high harmonic voltage distortion, above 10%, has resulted at all three of these locations on the medium-voltage distribution systems. This high-voltage distortion resulted in a number of operational problems and component failures. These included the misoperation of unbalance voltage relays, significant audible noise from surge capacitors, misoperation of refinery quality control equipment, component failures of low voltage equipment, and computer system misoperations.

This paper focuses on one of these three applications. Fig. 1 shows a partial system one-line diagram which includes the problem areas in the plant. The refinery is provided power by the utility at 115 kV. The total plant load is approximately 140 MW. The Alkylation (Alky) plant, which includes a 12-pulse LCI drive that supplies a 14 200-hp motor, is served power at the No. 1 Substation via two 60-MVA transformers that step down to 12.47 kV. Local refinery power generation includes

approximately 100 MW connected directly at the 115-kV service entrance and approximately 20 MW of generation in fairly close proximity, electrically, to the Alky plant. The power factor of the overall system was high enough that power-factor correction was not included with the drive system. There is a total of 18 Mvar of power-factor-correction capacitors on the 12.47-kV system which are located at several buses throughout the system. There are no nearby utility capacitor banks. There are no other significant harmonic producing loads on the system. The medium voltage insulated cable on the 12.47-kV system is mostly shielded, solid dielectric with some of the older circuits being of the paper-insulated lead-covered type. The insulated cables are either installed in underground conduit or are supported on poles by messenger wires. During the initial startup of the drive, some operational problems and component failures were experienced at loads served at the 12.47-kV Alky bus, Maleic bus, and the CRC bus. Problems included misoperation of timer circuits within analytical instruments that depend on voltage zero-crossing detection circuits, some digital clocks running fast, and some solid-state motor controller misoperations.

II. MEASURED HARMONIC DISTORTION

Harmonic measurements were made at selected locations on the plant's electrical system to investigate the problems associated with the operation of the 14 200-hp drive on the 12.47-kV Alky bus. Operational problems and component failures were reported at the 12.47-kV Alky bus, the Maleic bus, and the CRC bus. Table I summarizes the harmonic voltage measurements and Fig. 2 gives example waveforms with both lines to the Alky bus in service. Existing bus potential transformers (PTs) and current transformers (CTs) were used to make the measurements as they are generally quite accurate up to 5000 Hz. The voltage waveforms were obtained with a high-resolution oscilloscope to accurately record the high-frequency components of the waveform.

The voltage distortion measurements are summarized as follows.

- 1) The total harmonic voltage distortion (THD) ranged from 8.6% to 13.2% at the 12.47 kV Alky bus, which is where the LCI drive is located.
- 2) The THD ranged from 3.1% to 5.4% at other 12.47-kV buses on the system.
- 3) The voltage notch depth, due to the silicon-controlled rectifier (SCR) firing of the 12-pulse drive, was approximately 20% with both lines to the Alky bus in service and approximately 35% with only one line to the Alky bus in

Paper PID 00-11, presented at the 1999 IEEE Petroleum and Chemical Industry Technical Conference, San Diego, CA, September 13-15, and approved for publication in the IEEE TRANSACTIONS ON INDUSTRY APPLICATIONS by the Petroleum and Chemical Industry Committee of the IEEE Industry Applications Society. Manuscript submitted for review September 15, 1999 and released for publication August 12, 2000.

K. A. Puskarich and W. E. Reid are with Qual-Tech Engineers, Inc., Pittsburgh, PA 15241 USA (e-mail: kevin@QualTechEng.com; edreid@QualTechEng.com).

P. S. Hamer is with Chevron Research and Technology Company, Richmond, CA 94802 USA (e-mail: psha@chevron.com).

Publisher Item Identifier S 0093-9994(01)00279-6.

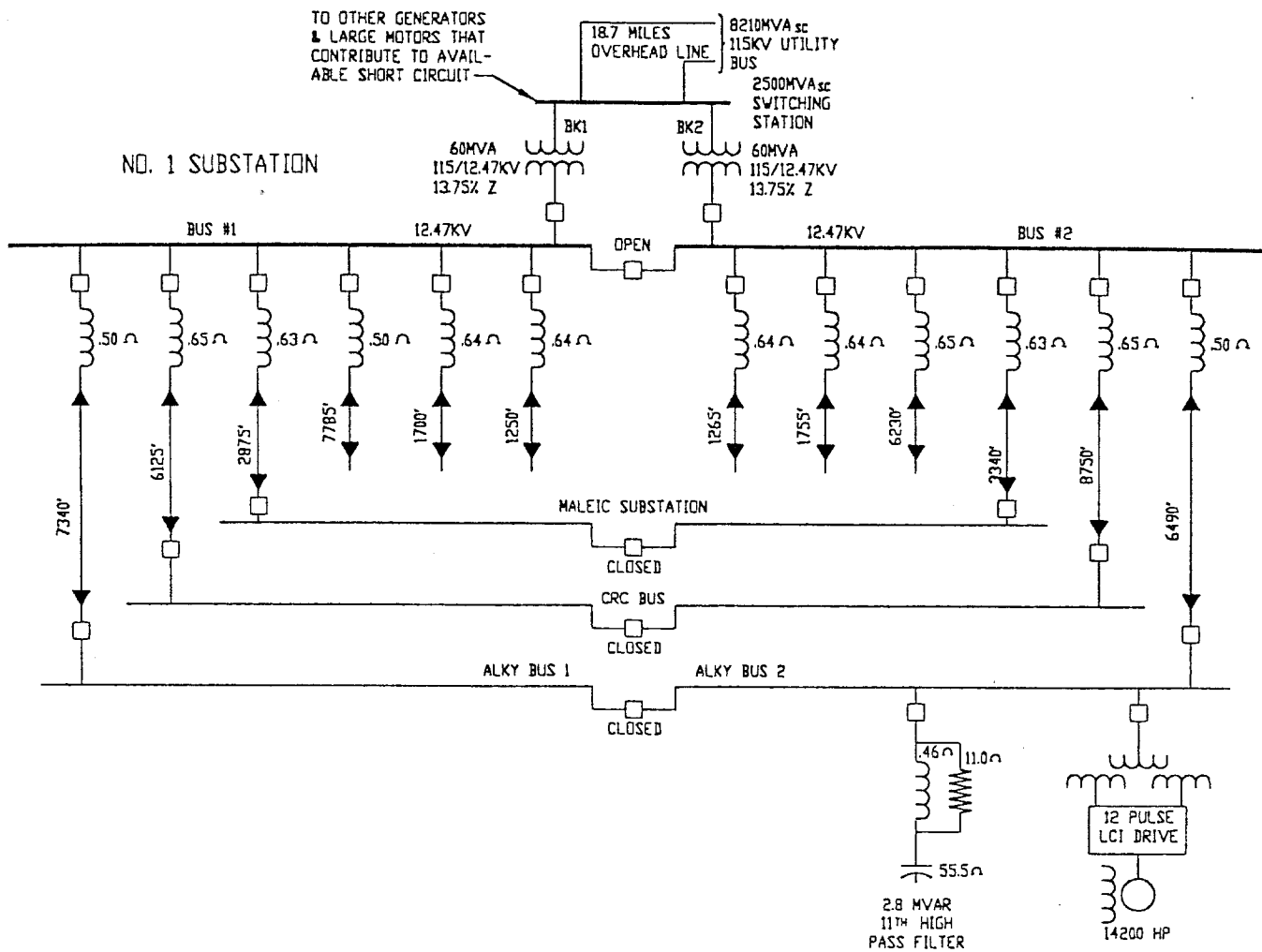

Fig. 1. System one-line diagram.

service. The fast change in voltage that is associated with the notch depth may cause multiple “zero crossings” of the voltage waveform that result in equipment misoperation.

The voltage distortion at the Alky bus is clearly above the industry recommended limit of 5% described in IEEE Std. 519. The distortion at the remote buses is near the limit. The notch depth, due to the SCR firing of the 12-pulse drive, is above the industry recommended limit of 20% when one of the lines to the Alky bus is out of service.

III. SIMULATIONS

In order to properly evaluate possible methods of reducing the harmonic distortion in the area of the 12.47-kV Alky bus a detailed harmonic system model was developed. The model extended from the 115-kV system down to each of the main 12.47-kV buses on the No. 1 Substation. Short-circuit equivalents were included at each of the boundary points of the system. The major capacitances on the system included the 12.47-kV cable capacitance, power-factor-correction capacitors in the plant, and the 115-kV transmission line capacitance. At the higher frequencies, the major damping on the system is provided by the core losses of all the transformers in the re-

finery connected to the 12.47-kV system. These losses increase exponentially with frequency. A frequency-dependent model of the transformer core losses was included in the simulation.

Harmonic impedance scans were obtained from the harmonic analysis computer model. These scans were then compared to the system harmonic impedance calculated from the actual field measurements to determine the accuracy of the model. The background distortion with the drive off was very low, especially at the characteristic frequencies of a 12-pulse drive. As a result, the calculation of the system impedance with the drive on was not significantly influenced by the background distortion.

Table II summarizes the actual harmonic voltage and current measured and the resultant harmonic impedance ($V/I = Z$). These calculations were made for two different source conditions with two different motor operating speeds. The system impedance values were quite consistent. Fig. 3 illustrates a comparison between the harmonic impedance scans obtained from the computer model and the values obtained from the field measurements. A good match was obtained for both source conditions, which verified the accuracy of the computer model.

The harmonic impedance scans of Fig. 3 show a parallel system resonance near the 60th harmonic or approximately 3.6

TABLE I
SUMMARY OF VOLTAGE DISTORTION MEASUREMENTS

RPM--> Harmonic	Voltage Distortion at 12.47 kV Buses (%)									
	Both Lines to Alky Bus in Service					One Line to Alky Bus in Service				
	3000 Alky Bus #2	2628 Alky Bus #2	2628 No.1 Sub Bus #2	2628 Maleic Bus	2628 CRC Bus	3000 Alky Bus #2	2628 Alky Bus #2	2628 No.1 Sub Bus #2	2628 Maleic Bus	2628 CRC Bus
THD	8.6%	9.2%	3.3%	3.9%	5.4%	13.2%	12.9%	3.4%	3.1%	3.7%
3	0.1%	0.1%	0.1%	0.1%	0.1%	0.1%	0.1%	0.1%	0.1%	0.1%
5	0.1%	0.1%	0.2%	0.2%	0.4%	0.1%	0.1%	0.2%	0.2%	0.4%
7	0.1%	0.1%	0.1%	0.1%	0.4%	0.1%	0.1%	0.1%	0.1%	0.4%
11	3.8%	3.0%	1.2%	1.1%	1.3%	5.8%	4.6%	1.4%	1.0%	1.2%
13	3.4%	2.3%	0.8%	0.7%	0.8%	5.3%	3.6%	0.9%	0.7%	0.7%
17	0.1%	0.1%	0.1%	0.1%	0.1%	0.1%	0.1%	0.1%	0.1%	0.0%
19	0.1%	0.1%	0.0%	0.1%	0.1%	0.1%	0.1%	0.1%	0.0%	0.1%
23	3.9%	3.3%	1.3%	1.3%	1.6%	4.6%	4.5%	1.3%	1.1%	1.2%
25	4.6%	3.7%	1.9%	1.9%	2.4%	4.9%	4.7%	1.8%	1.5%	1.9%
35	1.5%	2.1%	0.6%	0.7%	0.7%	1.5%	3.5%	0.7%	0.6%	0.6%
37	1.9%	2.6%	1.0%	1.2%	1.0%	1.7%	4.0%	1.0%	1.0%	0.8%
47	0.7%	2.8%	0.8%	1.1%	1.5%	2.3%	4.3%	0.8%	0.8%	1.0%
49	0.5%	2.5%	0.8%	1.2%	2.4%	2.9%	4.7%	0.9%	1.1%	1.8%
59	0.7%	3.2%	0.5%	1.3%	2.1%	2.5%	3.3%	0.6%	0.7%	0.7%
61	0.6%	3.2%	0.5%	1.3%	2.1%	2.5%	3.3%	0.6%	0.7%	0.7%

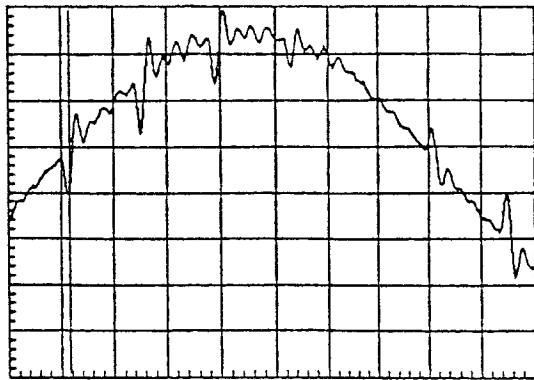

(a)

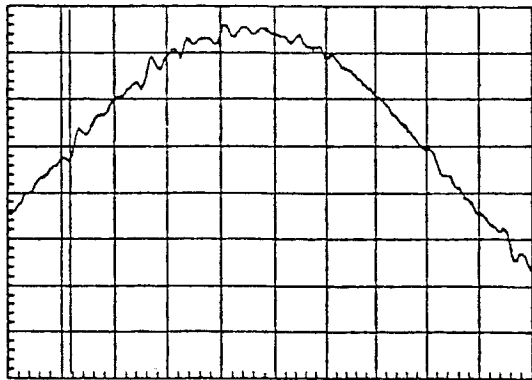

(b)

Fig. 2. Example measured voltage waveforms. (a) Alky 12.47-kV bus (1 ms/div). (b) Maleic 12.47-kV bus (1 ms/div).

kHz that is fairly damped. The system damping caused the peak resonant impedance to be relatively low but caused a wide band of frequencies to be magnified. The system damping at the higher frequencies was very sensitive to the transformer core losses. The frequency and magnitude of the main system resonance was mostly determined by the capacitance to ground of

the 12.47-kV cables that serve the Alky bus and the transformer core losses. The subtle characteristics of the system impedance between the 25th and 49th harmonics were substantially affected by the capacitance of other 12.47 kV cables fed from the No. 1 Substation and the capacitance of the 115-kV overhead transmission lines. Large power-factor-correction capacitors that were remotely located in relation to the Alky bus had little effect on the system impedance at and above the 11th harmonic. It should be noted that harmonics above the 50th harmonic are generally neglected since they are usually very small. In fact, IEEE Std 519 emphasizes analysis of the 35th harmonic and below. In this particular case, the higher order harmonics were substantial due to the natural parallel resonance of the system and were, therefore, included in the analysis.

The measured harmonic currents of the 14 200-hp LCI drive were injected into the computer model to calculate harmonic voltage distortion. In Table III, these harmonic voltage calculations are compared to actual measured quantities, which were documented in Table I. A reasonable match was obtained at all of the key 12.47-kV buses.

The actual measured voltage at the Alky bus, that is shown in Fig. 4, exhibits a significant voltage overshoot after the typical voltage notch. These overshoots cause the voltage waveform to have several voltage transients per fundamental cycle that are repetitive in nature. The waveshape was investigated by using an electromagnetic transients computer program. The transient model used the system parameters that were verified in the harmonic model. The power converters were also modeled and the firing angles of the SCRs were derived from the actual motor speed. Fig. 4 shows that the simulated waveform matches quite well with the measured waveform.

IV. SOLUTION

To reduce the harmonic voltage distortion in the area of the 12.47-kV Alky bus, several options were considered. Isolating

TABLE II
MEASURED HARMONIC SYSTEM IMPEDANCE AT ALKY 12.47-kV BUS

Both Lines to Alky Bus in Service							One Line to Alky Bus in Service						
Harmonic	Harmonic Voltage at Alky Bus #2 (Volts)		Harmonic Current of LCI Drive (Amps)		Impedance at Alky Bus (Ohms)		Harmonic	Harmonic Voltage at Alky Bus #2 (Volts)		Harmonic Current of LCI Drive (Amps)		Impedance at Alky Bus #2 (Ohms)	
	2628	3000	2628	3000	2628	3000		2628	3000	2628	3000	2628	3000
	RPM	RPM	RPM	RPM	RPM	RPM		RPM	RPM	RPM	RPM	RPM	RPM
1	7032.6	7032.3	366.1	555.6	-	-		6838.8	6794.7	365.7	559.2	-	-
11	211.0	267.2	36.4	49.6	5.8	5.4	11	314.6	394.1	35.6	47.7	8.8	8.3
13	161.8	239.1	24.2	36.9	6.7	6.5	13	246.2	360.1	24.2	35.8	10.2	10.1
23	232.1	274.2	15.7	17.9	14.8	15.3	23	307.8	312.6	14.8	14.7	20.8	21.3
25	260.2	323.5	13.4	15.9	19.4	20.3	25	321.4	333.0	12.8	12.9	25.1	25.8
35	147.7	105.5	9.2	6.7	16.1	15.7	35	239.4	101.9	8.2	3.5	29.2	29.1
37	182.9	133.6	8.7	6.3	21.0	21.2	37	273.6	115.5	7.9	3.3	34.6	35.0
47	196.9	49.2	5.9	1.3	33.4	37.9	47	294.1	156.3	5.0	2.6	58.8	60.1
49	175.8	35.2	5.7	1.0	30.8	35.2	49	321.4	197.1	5.2	3.2	61.8	61.6
59	225.1	49.2	3.9	0.8	57.7	61.5	59	225.7	169.9	2.8	2.0	80.6	84.9
61	225.1	42.2	3.8	0.7	59.2	60.3	61	225.7	169.9	2.7	1.9	83.6	89.4

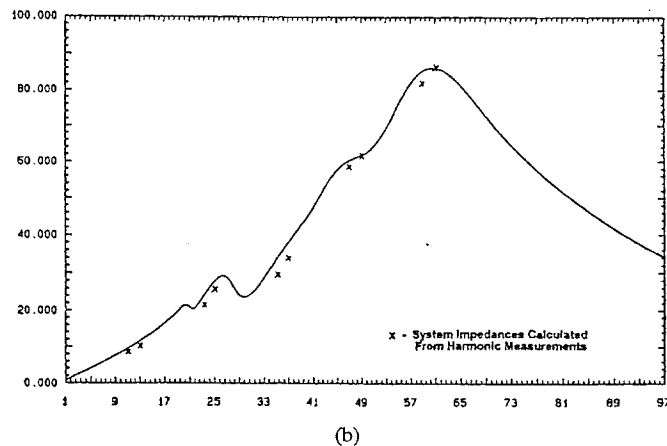
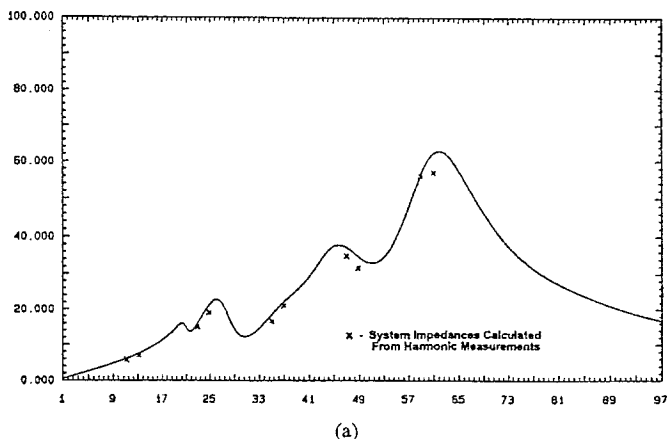

Fig. 3. Comparison of measured and simulated impedances. (a) Impedance scan at 12.47-kV Alky bus with both lines to Alky (ohms versus harmonic number). (b) Impedance scan at 12.47-kV Alky bus with one line to Alky (ohms versus harmonic number).

the large drive from the rest of the system or lowering the system impedance by the removal of current-limiting reactors was not practical in this application. Adding a high-pass filter at the 12.47-kV Alky bus was found to be both the most flexible and effective solution for reducing harmonic distortion.

Fig. 5 illustrates harmonic impedance scans at the Alky 12.47-kV bus with and without a 2.8-Mvar 11th harmonic

TABLE III
MEASURED AND SIMULATED VOLTAGE DISTORTION

12.47 kV Buses	Both Alky Lines In Service		One Alky Line In Service	
	Measured	Simulated	Measured	Simulated
	V_{THD} (%)	V_{THD} (%)	V_{THD} (%)	V_{THD} (%)
Alky Bus #2	9.2%	9.8%	12.9%	15.1%
No.1 Sub Bus #2	3.3%	3.6%	3.4%	3.7%
Maleic Bus	3.9%	4.0%	3.1%	3.3%
CRC Bus	5.4%	6.3%	3.7%	4.7%

high-pass filter for two system conditions. (The system one-line diagram in Fig. 1 shows the 60-Hz ohmic values of the filter components.) Calculating the harmonic voltages is simply a matter of $V = I \times Z$ at each frequency. The currents (I) are generated by the LCI drive. The impedance (Z) is a function of the system elements. In both cases, the system impedance at the 11th harmonic and above is dramatically reduced with the addition of the 11th high-pass filter which, in turn, results in lower voltage distortion. It should be noted that the filter resistor must have low inductance and the resistance must be fairly constant from 0 to 5000 Hz to obtain maximum effectiveness.

When a single-tuned filter is used, a parallel resonance exists at a frequency below the tuned frequency. For this application of an 11th harmonic filter, a relatively low magnitude parallel resonance is present between the 5th and 7th harmonics. To avoid excessive distortion at these frequencies, the addition of six-pulse harmonic loads must be carefully considered. In this case, the filter was designed to allow the addition of up to 2100 kVA of six-pulse harmonic load to the 12.47-kV No. 1 Substation.

Table IV gives the simulated harmonic voltage distortion with the 2.8-Mvar high-pass filter in service for two system conditions. The actual measured distortion with the filter in service is also given for reference. The distortion was less than 3.0% at the 12.47-kV Alky bus and less than 1.5% at remote buses. The distortion was well below the industry recommended limit of 5.0%. A comparison of the measured and simulated voltage waveforms at the 12.47-kV Alky bus is given in Fig. 6.

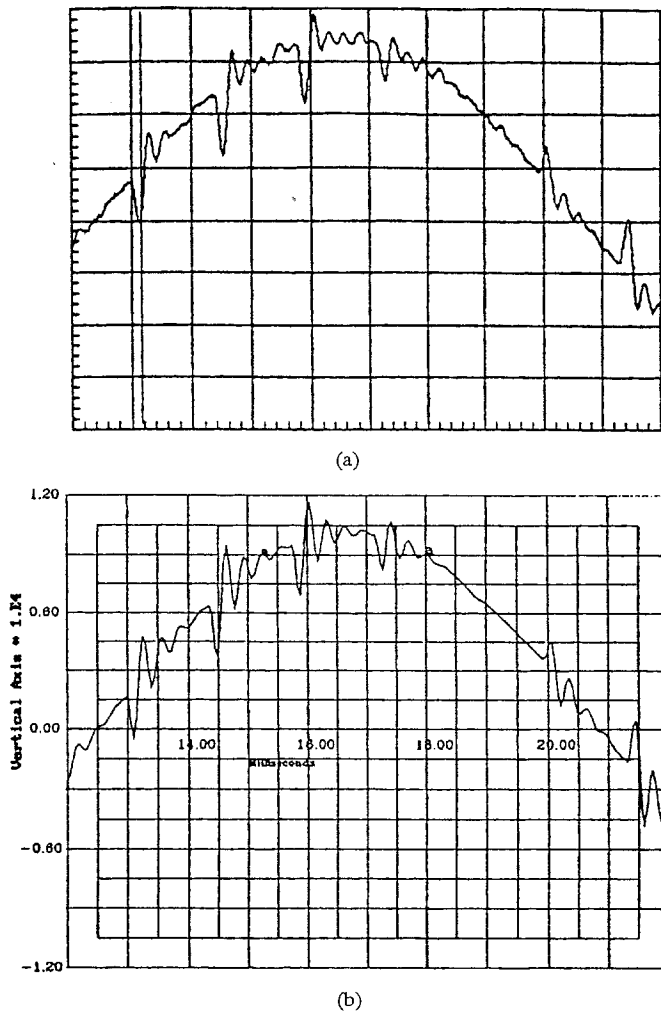

Fig. 4. Voltage waveforms at Alky bus. (a) Measured voltage waveform (1 ms/div). (b) Simulated voltage waveform (1 ms/major div).

V. PERFORMANCE MEASUREMENTS

A 2.8-Mvar 11th high-pass filter was installed at the 12.47-kV Alky bus. Harmonic measurements were made to verify the performance of the filter. Table V summarizes the measurements that were made after the filter was installed with the drive operating at approximately 2578 r/min. The following observations are made.

- 1) With the filter in service, the THD was reduced from 8.3% to 2.2% and the notch depth was reduced from 20% to 10% at the 12.47-kV Alky bus with both lines to the Alky bus in service.
- 2) With the filter in service, the THD was reduced from 14.0% to 2.4% and the notch depth was reduced from 35% to 10% at the 12.47-kV Alky bus with only one line to the Alky bus in service.
- 3) The harmonic voltage distortion at the 11th harmonic and above was significantly reduced when the filter was in service.
- 4) With the filter in service, the IT from the LCI drive at 12.47 kV was reduced from 142 000 to 31 000. ("I" is the rms current and "T" is the telephone interference factor.)

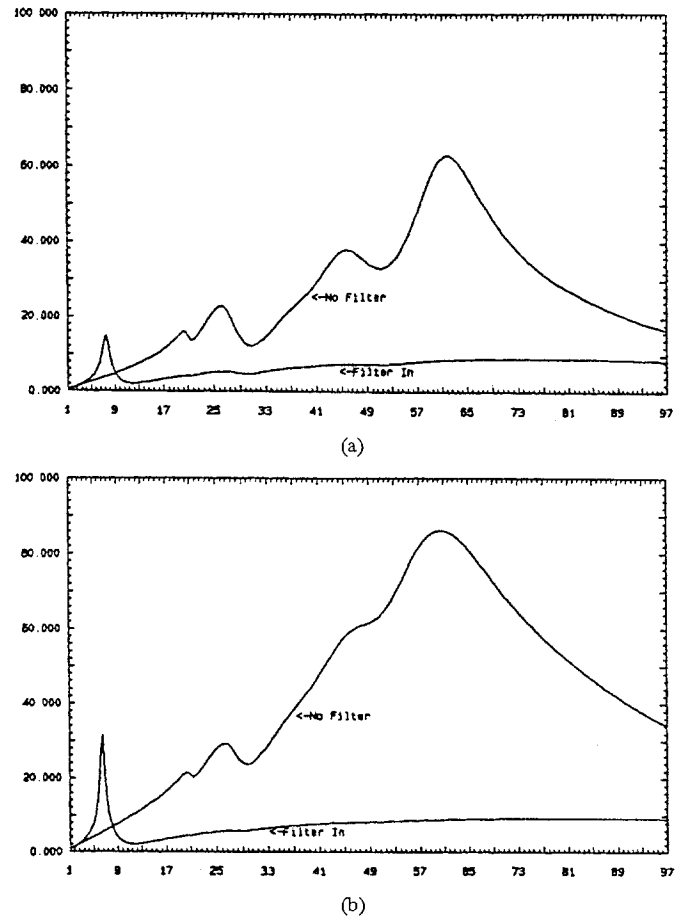

Fig. 5. Evaluation of the 11th harmonic high-pass filter. (a) Impedance scan at 12.47-kV Alky bus with both lines to Alky (ohms versus harmonic number). (b) Impedance scan at 12.47-kV Alky bus with one line to Alky (ohms versus harmonic number).

TABLE IV
MEASURED AND SIMULATED VOLTAGE DISTORTION WITH FILTER

12.47 kV Buses	Both Alky Lines In Service		One Alky Line In Service	
	Measured V_{THD} (%)	Simulated V_{THD} (%)	Measured V_{THD} (%)	Simulated V_{THD} (%)
Alky Bus #2	2.2%	2.5%	2.4%	2.7%
No.1 Sub Bus #2	0.9%	1.0%	---	0.7%
Maleic Bus	---	1.0%	---	0.6%
CRC Bus	1.3%	1.3%	---	0.8%

IEEE Std 519 indicates that levels above 25 000 will probably cause interference where overhead circuits are used for both power and telephone systems. No such problems occurred, and this was likely due to the fact that shielded cables are used to transmit power throughout the 12.47-kV system.

- 5) With the filter in service, the THD was less than 3.0% at the 12.47-kV Alky bus and less than 1.5% at remote buses. The distortion was well below the industry recommended limit of 5.0%.

Fig. 7 includes example voltage waveforms of the 12.47-kV Alky bus with and without the filter with both lines to the Alky bus in service. Fig. 8 illustrates the voltage with one line to the Alky bus in service.

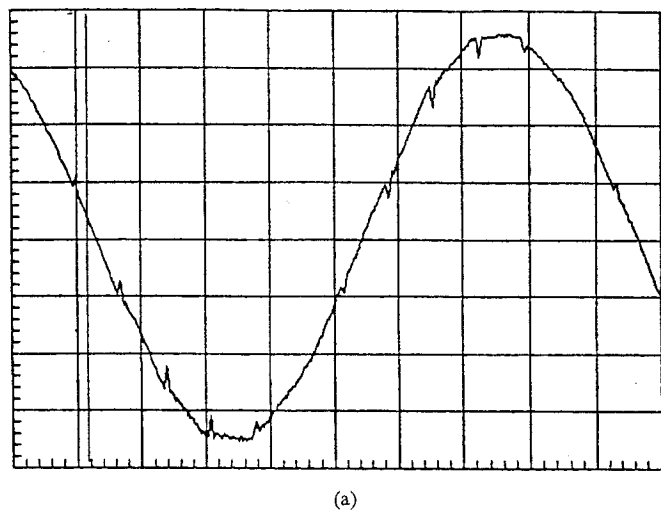

(a)

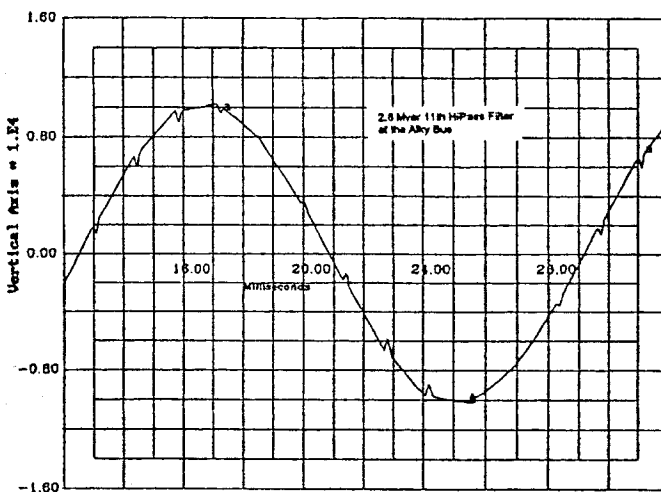

(b)

Fig. 6. Voltage waveforms at Alky bus with filter. (a) Measured voltage waveform (1 ms/div). (b) Simulated voltage waveform (1 ms/major div).

TABLE V
SUMMARY OF FILTER PERFORMANCE MEASUREMENTS

Harmonic	Both Lines to Alky				One Line to Alky	
	Filt. Off		Filter On		Filt. Off	Filt. On
	Alky Bus #2	Alky Bus #2	No.1 Sub Bus #2	CRC Bus	Alky Bus #2	Alky Bus #2
THD	8.3%	2.2%	0.9%	1.3%	14.0%	2.4%
3	0.0%	0.1%	0.1%	0.1%	0.1%	0.1%
5	0.2%	0.3%	0.3%	0.3%	0.2%	0.5%
7	0.1%	0.4%	0.3%	0.4%	0.1%	0.3%
11	2.5%	1.0%	0.3%	0.2%	4.0%	1.0%
13	1.9%	0.6%	0.2%	0.3%	3.0%	0.6%
23	2.7%	0.8%	0.3%	0.3%	4.1%	0.9%
25	2.8%	0.8%	0.3%	0.4%	4.0%	0.8%
35	2.1%	0.6%	0.2%	0.2%	3.8%	0.7%
37	2.7%	0.6%	0.2%	0.3%	4.3%	0.7%
47	2.3%	0.5%	0.2%	0.4%	4.7%	0.6%
49	1.8%	0.5%	0.3%	0.8%	4.8%	0.6%
59	3.4%	0.5%	0.1%	0.3%	4.7%	0.6%
61	3.3%	0.5%	0.1%	0.3%	4.7%	0.5%

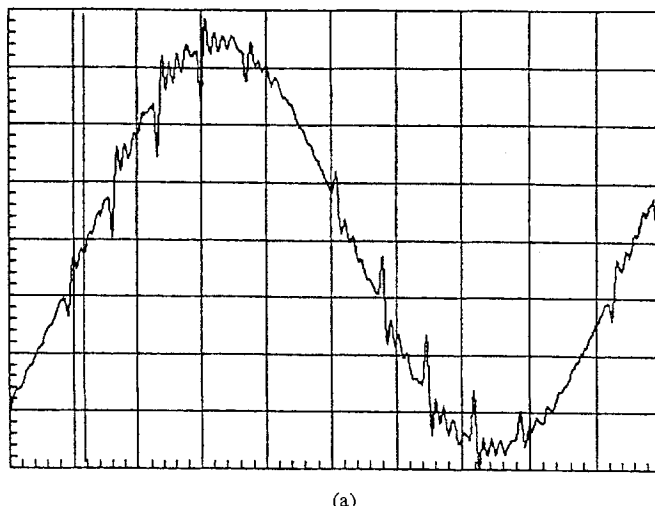

(a)

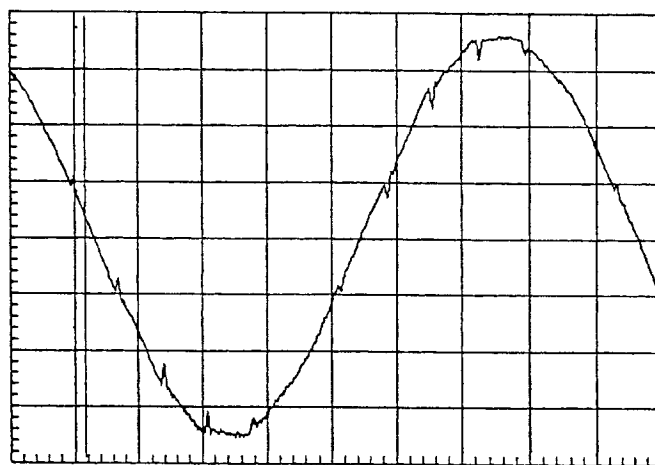

(b)

Fig. 7. Measured voltage with both lines in service. (a) Alky 12.47-kV bus with filter off line (2 ms/div). (b) Alky 12.47-kV bus with filter on line (2 ms/div).

VI. IEEE STD 519

IEEE Std 519 [1] gives a clear recommendation on voltage distortion limits with regard to the point of common coupling with the supplying utility. Although it is not clearly stated in the standard, many engineers have applied these voltage distortion limits within industrial and commercial facilities, while others have used higher limits within the plant. In this application, equipment problems were encountered with voltage distortion levels on the 12.47-kV system that were at or marginally above the 5% value which is suggested in IEEE Std 519. In a large facility, such as a refinery, where there is exposure to many different types of electrical components, such as motor controllers, programmable-logic controllers, computers, etc., there is a high probability that there will be some components that will not operate properly in a marginally high harmonic environment. Given this experience, the authors recommend that IEEE Std 519 be revised to clearly recommend that these voltage distortion limits be applied within users' facilities as well as on utility systems.

The application examples given in IEEE Std 519 go up to the 35th harmonic. The need to analyze harmonics higher than the 35th in some cases should also be emphasized.

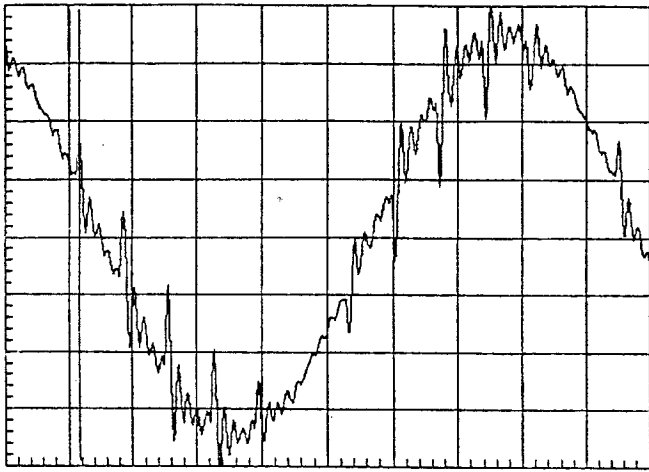

(a)

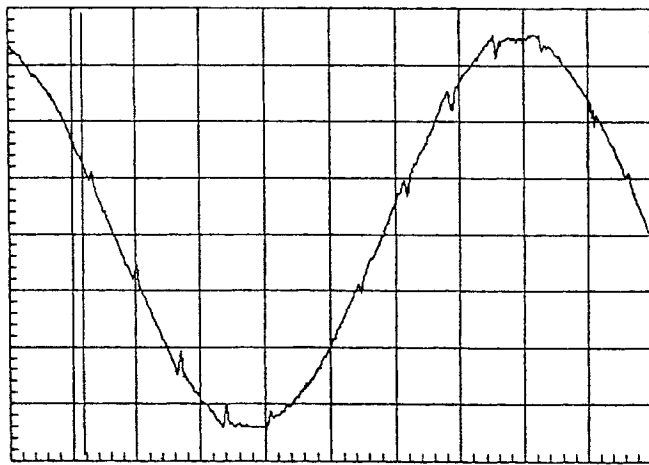

(b)

Fig. 8. Measured voltage with one Alky line in service. (a) Alky 12.47-kV bus with filter off line (2 ms/div). (b) Alky 12.47-kV bus with filter on line (2 ms/div).

VII. CONCLUSIONS

Based upon this analysis, the following conclusions are made.

- 1) The combination of system resonance at relatively high frequencies, which is commonly caused by cable capacitance, and the presence of a large harmonic load can cause substantial distortion at frequencies above the 25th harmonic.
- 2) The magnitude of the harmonic distortion at frequencies above the 25th harmonic is affected by system losses that tend to be dominated by transformer core losses.
- 3) The system harmonic distortion can be accurately predicted with a harmonic analysis computer program if a detailed model is developed. The harmonic model must give special attention to the capacitance of cables, transmission lines, and surge capacitors. Also, transformer core losses provide substantial damping and must be considered.

- 4) Field harmonic measurements can be very helpful in the development and verification of the harmonic model.
- 5) Once an accurate model is developed and verified, solutions for reducing harmonic distortion can be confidently evaluated.
- 6) A properly designed high-pass filter can be very effective in controlling troublesome harmonic distortion for a wide range of harmonics and a wide variety of system operating conditions.
- 7) Based on our experience, it is recommended that IEEE Std 519 be revised to clearly recommend that the voltage distortion limits be applied within industrial and commercial facilities. Consideration of harmonics higher than the 35th should also be addressed by an application example.

REFERENCES

- [1] *IEEE Recommended Practices and Requirements for Harmonic Control in Electrical Power Systems*, ANSI/IEEE Std 519-1992.
- [2] W. E. Reid, "Capacitor application considerations—Utility/user interface," presented at the IEEE/PES T&D Conf. and Exposition, Panel Session on Capacitor Bank Design and Application, New Orleans, LA, Apr. 1989.
- [3] P. B. Steciuk, K. A. Puskarich, and W. E. Reid, "Harmonic considerations on low voltage systems," in *Proc. IEEE 1991 Textile, Fiber, and Film Industry Tech. Conf.*, pp. —<AUTHOR: PAGES?>.
- [4] W. E. Reid and K. A. Puskarich, "Harmonic filter application criteria," presented at the IEEE/PES 1994 Winter Power Meeting Panel Sessions, New York, NY, Feb. 2, 1994.
- [5] W. E. Reid, "Power quality issues—Standards and guidelines," *IEEE Trans. Ind. Applicat.*, vol. 32, pp. 625–632, May/June 1996.
- [6] W. E. Reid and K. A. Puskarich, "Power system harmonic and transient measurements—Know what to expect," presented at the 1999 IEEE/PES Transmission and Distribution Conf. Panel Session, New Orleans, LA, Apr. 15, 1999.
- [7] W. E. Reid, "Capacitor application considerations—Utility/user interface," presented at the 1991 Pulp and Paper Industry Tech. Conf., <AUTHOR: LOCATION AND DATES OF CONFERENCE?>, Paper CH2973-6/91/0000-0070.
- [8] P. B. Steciuk, K. A. Puskarich, and W. E. Reid, "Harmonic considerations on low voltage systems," presented at the 4th Int. Power Quality Conf., Universal City, CA, Sept. 22–27, 1991.
- [9] W. E. Reid and K. A. Puskarich, "Harmonic filter application criteria," presented at the IEEE/PES 1994 Summer Power Meeting, San Francisco, CA, July 28, 1994.



Kevin A. Puskarich is a Senior Power Systems Engineer with Qual-Tech Engineers, Inc., Pittsburgh, PA. He has more than 15 years experience in the analysis of industrial and utility electrical power systems with Qual-Tech Engineers and Cooper Power Systems. His primary areas of experience have included transient and harmonic analysis to determine equipment ratings, operating procedures, and equipment protection schemes, as well as the performance of equipment failure analysis. Analysis tools have included the transient network analyzer, digital com-

puter programs, and field measuring equipment. The power system studies have included harmonic filter design, harmonic and transient field measurements, short-circuit and coordination analyses, arc furnace studies, shunt and series capacitor applications, static var systems, transmission line switching, and HVdc applications.



W. Edward Reid (S'72-M'74) received the B.S.E.E. and M.S.E.E. degrees from West Virginia University, Morgantown.

He is Director, Analytical Studies, with Qual-Tech Engineers, Inc., Pittsburgh, PA. He has more than 25 years experience in electrical power system analysis with Qual-Tech Engineers, Cooper Power Systems, and American Electric Power. His experience has contained a special emphasis on problem solving, including shunt and series capacitor applications, filter design from low-voltage industrial to HVdc ap-

plications, equipment insulation failures, switchgear transient recovery voltage considerations, power quality and power outage problems, and equipment application considerations. He has coauthored more than 20 technical papers.

Mr. Reid was the Chairman of the IEEE Capacitor Subcommittee. He also is or has been a member of the IEEE Power Engineering Society, Pulp and Paper Industry Committee of the IEEE Industry Applications Society, Working Group on Transient Recovery Voltages, and several other groups. He is a Registered Professional Engineer in the States of New York and New Jersey.



Paul S. Hamer (S'70-M'74-SM'89-F'97) received the B.S.E.E. degree from Virginia Polytechnic Institute and State University, Blacksburg, and the M.S.E.E. degree from Oregon State University, Corvallis, in 1972 and 1979, respectively.

From 1972 through 1977, he was with Westinghouse Electric Corporation, where he was a Service Performance Engineer with the Large Generator Department and an Industrial Power System Engineer and Resident Engineer with the Industry Services Division. In 1979, he joined

Chevron Corporation, where he is currently a Senior Staff Engineer, Electrical Machinery and Power Systems, with Chevron Research and Technology Company, Richmond, CA. His primary responsibilities include power system, motor, and generator application and consultation. He has worked on many refining, chemical, and oil production projects during his career with Chevron. As a member of the American Petroleum Institute (API) Subcommittee on Electrical Equipment, he has contributed to the API standards for induction and synchronous machines and the API recommended practice on electrical area classification. He represents the API on the National Electrical Code, Code Making Panel 11, on the subjects of motors, motor circuits, and controllers, and on the technical committee for NFPA 70E, *Standard for Electrical Safety Requirements in Employee Workplaces*.

Mr. Hamer has been an active member of the Petroleum and Chemical Industry Committee of the IEEE Industry Applications Society since 1981. He is a Registered Professional Electrical Engineer in the State of California.