

Capacitor Application Consideration – Utility/User Interface

– By –

W. Edward Reid

Copyright © 1991 IEEE

Reprinted from the Conference Record of the
1991 Annual Pulp and Paper Industry Technical Conference
(Paper CH2973-6/91/0000-0070)

This material is posted here with permission of the IEEE. Such permission of the IEEE does not in any way imply IEEE endorsement of any of Qual-Tech Engineers' products or services. Internal or personal use of this material is permitted. However, permission to reprint/republish this material for advertising or promotional purposes or for creating new collective works for resale or redistribution must be obtained from the IEEE by writing to pubs-permissions@ieee.org.

By choosing to view this document, you agree to all provisions of the copyright laws protecting it.

CAPACITOR APPLICATION CONSIDERATIONS- UTILITY/USER INTERFACE

W. EDWARD REID
QUAL-TECH ENGINEERS

Presented at 1991 IEEE Pulp and Paper Industry Technical Conference (Paper CH2973-6/91/0000-0070)

Abstract - The continually increasing use of capacitors throughout utility and industrial power systems has resulted in an increased awareness level of the application considerations associated with capacitor switching and harmonics. This paper reviews these topics from a systems point of view, emphasizing the system interaction effects and the means that can be used to minimize this interaction.

INTRODUCTION

Over the last decade there has been a significant increase in the use of shunt capacitors in both utility and industrial applications. With utilities a number of trends and events have led to this situation:

A reduction in the addition of new AC lines due to a slowing of load growth in certain areas as well as an increase in the difficulty of obtaining new rights-of-way.

An increase in the use of DC lines and DC back-to-back terminals.

An increase in the need for power transfer capability due to generation availability in certain parts of the country and generation shortages in other areas.

All of these conditions have resulted in a greater need for capacitive var supply which can be obtained with relatively short lead times through the use of shunt capacitors compared to other alternatives.

In the industrial area there has also been an increase in the need for shunt capacitors:

More utilities implemented and enforced billing penalties associated with low power factor.

The increased use of power electronic controlled loads has brought an increase in the need for filter capacitor banks.

In applying capacitors there are a number of system considerations that can be important factors in assuring that the bank and the rest of the system operate in a reliable manner. Often these considerations not only apply to the system where the capacitor bank is being located, but also to adjacent utility and industrial power systems. This paper focuses on the two major areas of a reliable power system interface as it involves capacitors--switching transients and harmonics.

CAPACITOR SWITCHING CONSIDERATIONS

Switching capacitors has been discussed in the technical literature for over 50 years. [1] The papers have generally been a mix of application oriented topics and switchgear design and test considerations. The significance of this topic can be put in perspective when one realizes that the switching of capacitors is the most common source of transient voltages on many systems and second only to lightning on many others. This statement is generally true because many capacitor banks are switched twice a day--on in the morning and

off in the evening. A vast majority of the time, however, the switching of a capacitor bank results in a harmless transient. In this section of the paper some of the more significant concerns related to capacitor bank switching are discussed as they affect other equipment on the interconnected power system.

For many years oil breakers were commonly used to switch capacitor banks at virtually all voltage levels with some applications using air blast and air magnetic breakers. A high percentage of these breakers, when used in capacitor applications, inserted resistors in the circuit during both the closing and opening operations. These resistors were in the circuit to minimize the transient recovery voltage across the breaker contacts during the opening operation. In the 60's and 70's vacuum and gas interrupters were introduced. One of the results for capacitive switching is that these devices do not generally require resistors to meet the standard switch or breaker duty requirements. This wide use of switching devices that do not employ resistors leads to a situation that makes for higher system transient voltages during capacitor switching.

In the 1980's the use of switched shunt capacitor banks at higher and higher voltages continued to increase significantly. This increase in the number of applications coupled with the common practice of applying capacitor switching devices without resistors and the continual financial incentive to reduce equipment and system BIL levels led to a number of papers on these topics. For an historical perspective, references 2, 3, and 4 and their discussions provide significant insight into several of the application problems and into the switch design considerations associated with capacitor switching. References 5 to 12 give examples of the significant application considerations which were discussed over the last decade regarding this topic.

In the remainder of this section, capacitor switching as it affects the power systems will be discussed, rather than as it affects the capacitor installation itself. (It should be noted that other types of system events besides capacitor switching may result in similar transient overvoltages on the system.)

Normal Energizing

In Figure 1 a transient voltage at a bus where a capacitor bank is being energized is illustrated. This is typical of energizing a single capacitor bank with no other capacitor bank connected to that same bus. This waveform shows the capacitor bank switch closing at the peak of the voltage waveform. The bus voltage changes to the value of the trapped voltage on the capacitor bank in a very short time. In the normal case the voltage on a capacitor bank that is being energized is zero. The voltage change generally occurs in a fraction of a microsecond to a few microseconds depending upon the inductance and the surge impedance of the system at that point. After this quick change in voltage occurs, the bus voltage attempts to recover to the normal 60 Hz value. It overshoots and approaches a value of two times the normal peak voltage resulting in an oscillatory transient that is determined by the system inductance and the capacitor bank capacitance. In evaluating the effect of this transient on the remainder of the system, its key characteristics are the fast front surge that occurs initially and the oscillatory transient that follows.

Figure 2 shows the bus voltage associated with energizing a capacitor bank when there is an equal size bank on the same bus and each bank has an inrush reactor in series with it. The bus voltage is actually lower in this case compared to that in Figure 1 for the isolated bank. The capacitors see a much higher frequency component that does not appear on the main bus when reactors and capacitors of equal value are used. When the reactors and capacitors are not equal, the higher frequency component will occur on the main bus.

Fast Front: The fast front portion of the capacitor switching transient raises two major areas of concern for other power system equipment: transformers and low voltage equipment.

Transformer failures associated with capacitor switching have been documented in several publications. [3, 4, 11] The causes of these failures have generally been linked to two different problems: excessive phase-to-phase transient voltages and transformer part winding resonance.

In determining insulation margins between arrester protective levels and equipment withstand capabilities, phase-to-ground values are used. This is normally done because lightning generally dictates insulation and protection levels. With lightning the phase-to-phase voltage is usually less than the phase-to-ground value because a voltage of the same polarity as the struck phase is coupled to the other two phases. With switching surges it is very likely to get a significantly higher phase-to-phase transient, especially when switching an ungrounded wye capacitor bank. In references 9 and 11 it was shown that transformers at the end of a radial line emanating from a bus where a capacitor bank is switched could see transient voltages on two phases of opposite polarity which are equal to the arrester protective level. Figure 3 illustrates such a transient voltage. [11]

In Table 1 protective margins for phase-to-phase protection are given for typical transformer BIL's and typical metal oxide (MOV) arresters. This was evaluated at the 10 kA discharge point. (One could argue that a different value should be used for this comparison depending upon the shape of the transient voltage. However, the 10 kA point is a reasonable value for comparison purposes.) It is normal practice to maintain a 20% margin between the 10 kA arrester protective level and the transformer BIL. It is clear from this table that low BIL units would have a difficult time maintaining the 20% margin, especially with higher rated arresters.

Therefore, transformers which meet the following conditions are especially vulnerable to seeing excessive phase-to-phase transient voltages:

- The transformer is at the end of a line.
- The transformer emanates from a substation which has a switched capacitor bank.
- The transformer is of a low BIL with a high rated surge arrester.

It is important to note that the actual magnitude and shape of the transient is dependent on the system parameters including line length, capacitor bank size and connection, transformer parameters, switching method, system connected at capacitor substation, and system connected at transformer substation.

The second type of transformer transient of concern is that referred to as part winding resonance. In this case an oscillatory or repetitive transient occurs at the terminal of the transformer. If the major frequency of this transient coincides with a natural frequency of the transformer, then the transient voltage can be amplified within the transformer resulting in an excessive overvoltage and an insulation failure. An example of such waveforms is illustrated in Figure 4. [11] This situation is relatively difficult to predict due to the difficulty of predicting transformer resonant frequencies in advance. However, advances are continually being made in this area. [13]

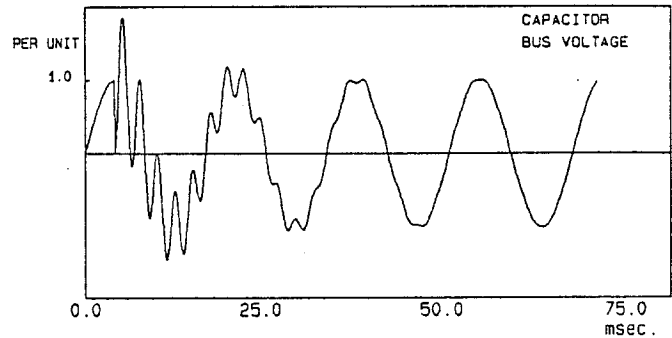
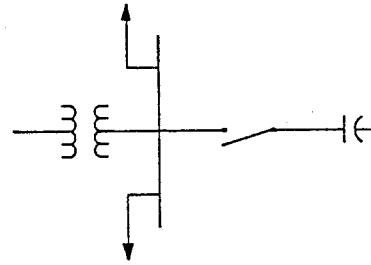

Fig. 1 Energizing an Isolated Capacitor Bank

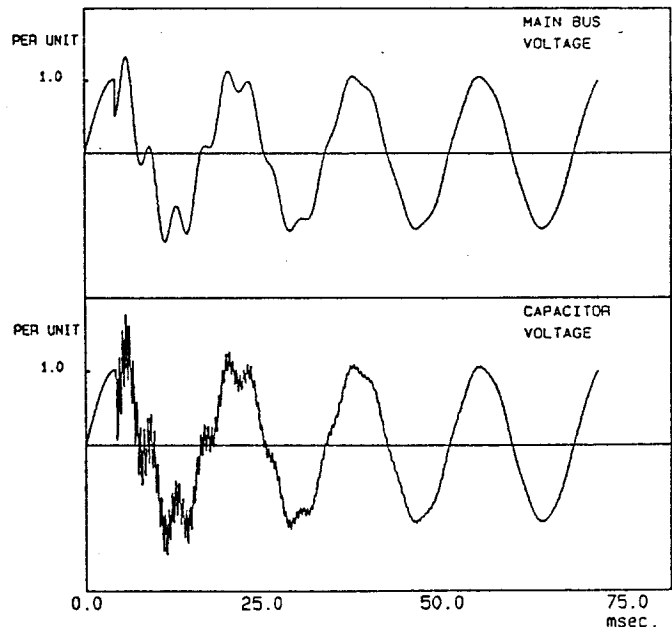
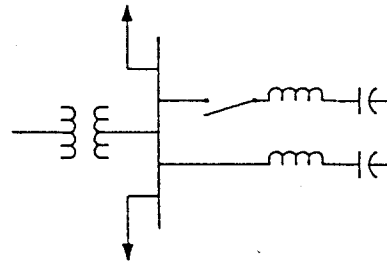

Fig. 2 Energizing a Capacitor Bank Back-to-Back

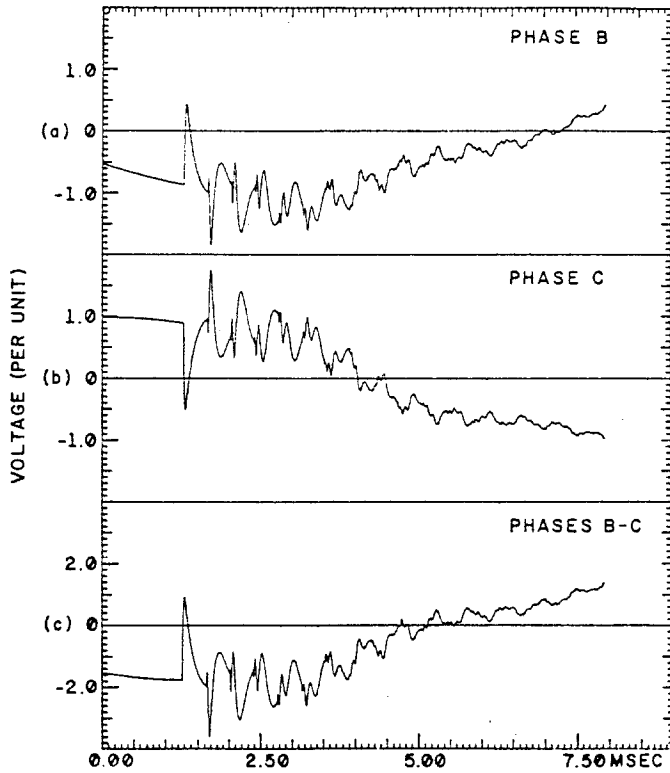
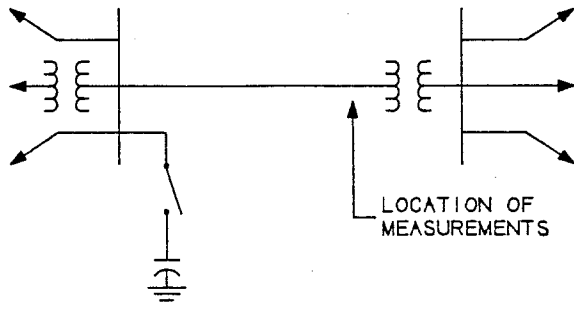

Fig. 3 Example of Phase-to-Phase Voltage [11]

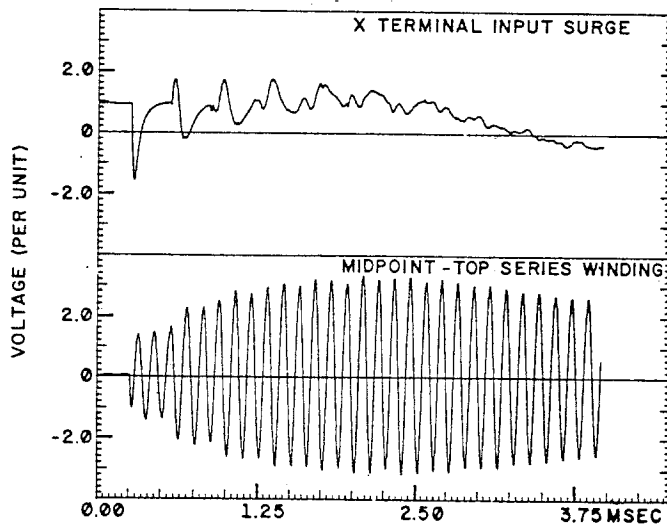

Fig. 4 Example of Transformer Part Winding Resonance [11]

Table 1
Transformer Protective Margins
for Phase-to-Phase Transients

System kv	BIL (kv)	Protective Margin (%) for Surge Arresters Listed		
		3 kv	4.5 kv	6 kv
4.16	30	81%	26%	-7%
	60	261%	152%	86%
	75	352%	215%	133%
7.20	45	40%	17%	-6%
	75	133%	94%	56%
	95	195%	146%	98%
13.80	60	12%	-6%	-25%
	95	78%	48%	19%
	110	106%	72%	38%
34.50	125	-9%	-18%	-32%
	150	9%	-2%	-18%
	200	46%	31%	9%
46.00	200	9%	1%	-18%
	250	36%	26%	2%
	69.00	250	54 kv	60 kv
69.00	250	2%	-8%	-23%
	350	43%	29%	7%
	115.00	350	90 kv	96 kv
115.00	450	-14%	-20%	-36%
	550	10%	3%	-17%
	550	35%	26%	1%
138.00	450	108 kv	120 kv	144 kv
	550	-8%	-17%	-31%
	650	12%	1%	-16%
161.00	650	33%	19%	-1%
	750	120 kv	132 kv	168 kv
	750	1%	-8%	-28%
230.00	650	19%	9%	-14%
	750	38%	25%	-1%
	900	172 kv	192 kv	240 kv
230.00	825	-17%	-25%	-40%
	900	4%	-14%	-31%
	900	6%	-5%	-24%
345.00	900	15%	3%	-17%
	1050	258 kv	288 kv	312 kv
	1175	-23%	-31%	-36%
500.00	1300	-10%	-19%	-26%
	1425	1%	-10%	-17%
	1675	396 kv	420 kv	444 kv
765.00	1300	-27%	-32%	-38%
	1425	-20%	-25%	-31%
	1550	-14%	-18%	-25%
765.00	1675	-7%	-12%	-19%
	1800	588 kv		
	1925	-32%		
2050	2050	-28%		
	2050	-23%		

The second major effect of the fast front portion of the transient is on low voltage equipment. This fast front transient will tend to transfer through a transformer by its capacitance ratio rather than its turns ratio which can result in a much higher secondary voltage. This type of transient tends to be higher on unloaded or lightly loaded secondary circuits. Electronic equipment, dry type transformers, and motors are especially susceptible to these types of transients. Figure 5 illustrates the capacitive transfer through a transformer.

Oscillatory: The oscillatory portion of the capacitor switching transient raises the same two areas of concern as the fast front portion: transformers and low voltage equipment.

For transformers the oscillatory portion of the transient could excite the part winding resonance condition in the transformer. Practically, the frequency of the system transient is usually of too low a frequency (typically less than 1 kHz for an isolated bank and less than 5 kHz for back-to-back switching) to excite a transformer's natural frequencies (typically 10 kHz to 100 kHz). The transient initiated by the fast front portion of the wave is more likely to cause this problem as illustrated in Figure 4.

For lower voltage equipment the oscillatory transient can be quite significant. The circuit of concern is illustrated in Figure 6. (This topic was discussed extensively in reference 2.) Basically, the potential problem is that the switching of a large high voltage capacitor bank can cause a much higher per unit transient voltage to occur at the location of a smaller low voltage capacitor bank. The most severe condition occurs when $L_1 \times C_1$ is nearly equal to $L_2 \times C_2$. This condition is illustrated by the waveforms in Figure 7. While the normal energizing transient at the capacitor may be less than 2.0 per unit, the voltage at the lower voltage capacitor may be in the range of 3.0 to 5.0 per unit. This transient may result in arrester failures, other equipment failures, and/or equipment misoperation, such as drives.

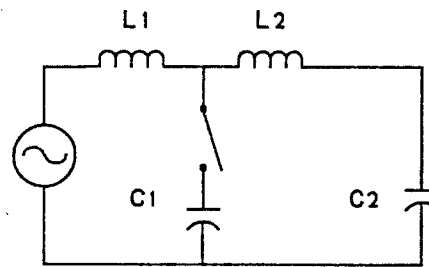
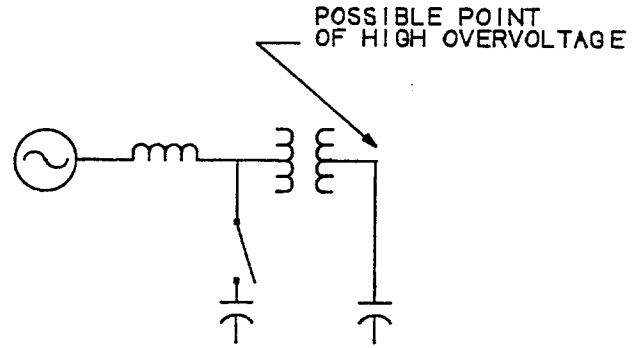
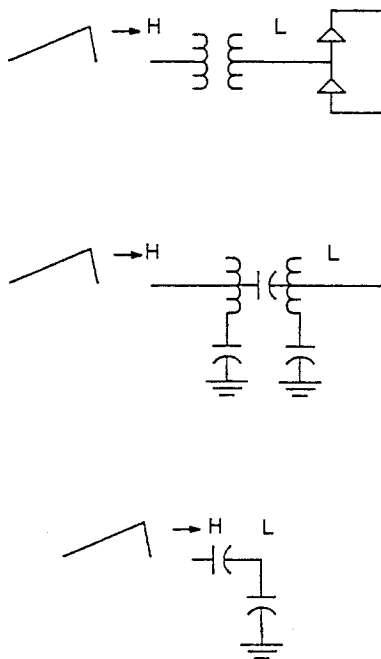

Fig. 6 Capacitor Switching Magnification Circuit



EQUIVALENT CIRCUIT

Fig. 5 Transfer of Fast Front Surges Through a Transformer

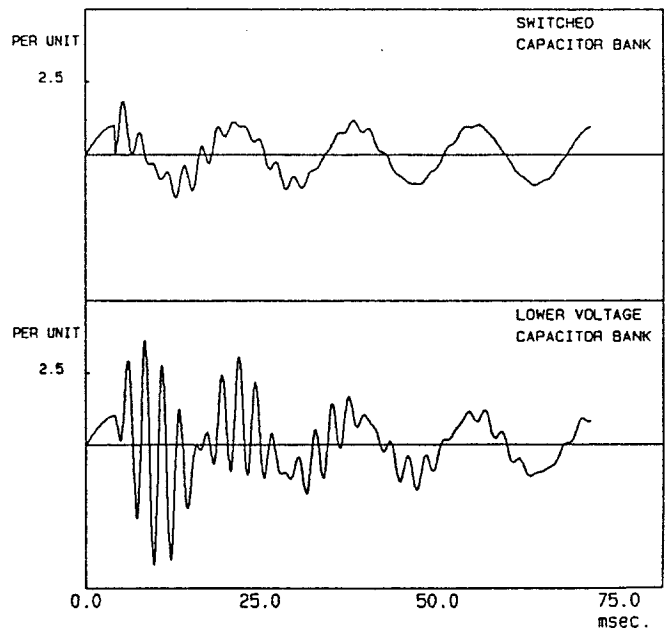

Fig. 7 Capacitor Switching Magnification Overvoltage

Prestriking

Prestriking is a switch characteristic that may occur upon closing of the switch. This occurs when current flow is established before the contacts physically make contact. During this condition certain interrupters have been known to temporarily interrupt the high frequency inrush current at its current zero. Repeated interruptions during the energization process can lead to multiple transient events with a possible escalation in the voltage. The transient characteristics are the same as those discussed above but the magnitudes and the repetitive nature of the transients may be more severe. [3,4] Contact bouncing upon energization may result in the same transient characteristics. This was a more likely characteristic of early vacuum switch designs than of current switchgear designs.

Restriking

Restriking is a resumption of current between the contacts of a switching device during an opening operation after an interval of zero current of 1/4 cycle at normal frequency or longer. Normally, when using a switching device that is designed for capacitive switching duty, the interruption upon opening is clean and virtually no transient occurs on the system. When a restrike(s) occurs, the transient voltage can be quite high. Under such conditions it is possible to see several restrikes and the switching device itself may ultimately clear without suffering any apparent damage. Since there is trapped voltage on the capacitor, the transient voltage that results can be much greater than the normal energizing transient. This results in the same wave shape characteristics as was discussed above but the magnitudes can be much higher. An example of a restrike transient at the capacitor bus is given in Figure 8.

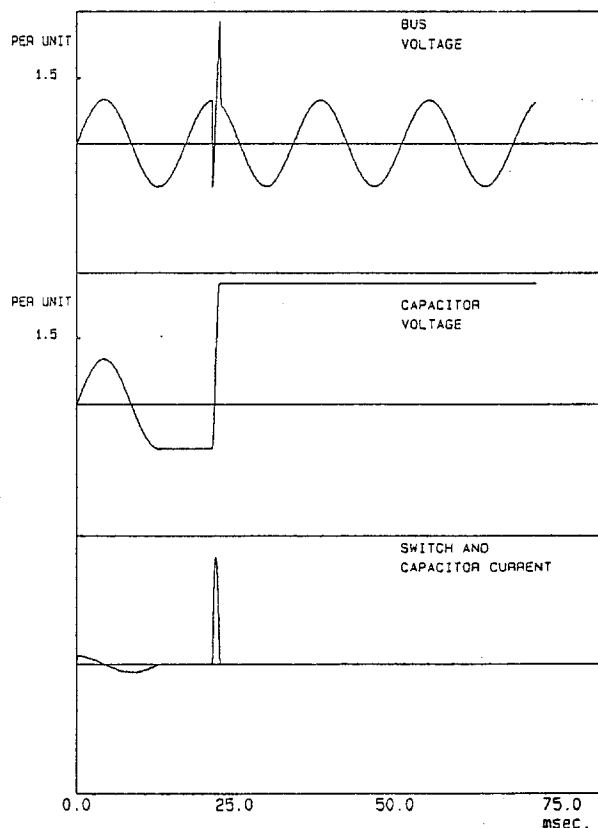

Fig. 8 Capacitor Bank Restriking Transient

Methods of Reducing Switching Transients

There are a number of steps that can be taken to reduce the fast front and oscillatory characteristics of the capacitor bank switching transient.

Closing Resistors: The use of closing resistors in the switching device is a very effective method to reduce the transient. It should be noted that one resistor value is not necessarily the most effective for all applications. When a resistor is used, a transient occurs when the switch first closes and also when the resistor is bypassed. If a very large resistor is used the transient can be higher when the resistor is bypassed than for the initial closing event. The use of a resistor can also help to minimize the effects of prestrike.

Controlled Closing: In some switching devices it is possible to control the point of closing of the switch so as to minimize the transient voltage.[8] If the contacts close when the voltage across them is nearly zero, the transient will be greatly reduced.

Staggered Closing: In grounded wye banks it is possible to reduce the phase-to-phase transient by staggering the closing times to insure that no two phases close together. This does not help for ungrounded wye banks.

Reactors: A reactor in each phase of the capacitor bank also acts to reduce the transient voltage. The reactor can be permanently in the circuit or can be inserted temporarily during the closing operation.

Surge Arresters: During normal energization a surge arrester applied at the capacitor bank would not have any effect. It would be beneficial should a restrike occur. When deenergizing capacitor banks, switch restrikes may occur occasionally. They will tend to result in more severe transients than normal closing. In addition, some precautions which have been taken to minimize closing transients may be ineffective for the contingency condition of a switch restrike. These would include closing resistors or reactors, controlled closing, and staggered closing. Opening resistors and surge arresters are the most effective methods in minimizing restrike transients. Reactors may help somewhat. Often arresters are applied directly at the capacitor bank when arresters with lower protective levels are available than those currently in the substation. The capacitor bank arresters can better protect the rest of the system and they may actually protect the remainder of the arresters in the substation from a capacitor bank energy discharge during a restrike condition. In an ungrounded wye bank, placing the arrester on the capacitor bank side of the switch will help to reduce the switch recovery voltage during a restriking event and consequently help to reduce the number of restrikes that may occur.

HARMONIC CONSIDERATIONS

With the wide use of power electronics throughout industry, the concern for controlling waveform distortion or harmonics has increased significantly over the past decade. Controlling harmonics by applying filters has been common in such applications as arc furnaces, aluminum smelters, and chemical processes for a number of years. More recently it has become a common consideration in virtually all industrial plants. Although there are many types of loads and load control devices that cause waveform distortion, one of the most common is the 6-pulse thyristor controlled bridge. In Figure 9 the AC load current and the system voltages are shown for a typical 6-pulse rectifier. In Figure 10 the effect of applying a capacitor on the system voltage is illustrated for a near resonant condition. The notching effect has been replaced by a fifth harmonic distortion. In Figure 11 the voltage distortion is controlled by converting the capacitor to a filter. The filter significantly reduces the voltage distortion from that shown in Figures 9 and 10.

A typical simplified one line diagram of a modern day industrial plant is shown in Figure 12. It is very common for a plant to be composed of a combination of power converter controlled loads and induction and synchronous motors. In Figure 13 the equivalent circuit of the system shown in Figure 12 is given for making harmonic calculations. For most power electronic circuits the harmonic current content is very predictable; thus, they can be treated as harmonic current sources as illustrated in Figure 13.

Calculating the harmonic currents and voltages throughout the system is simply a matter of $V = I \times Z$ for a wide range of system conditions. The currents are generated by the power converters and the impedance is a function of the system elements. For this reason it is very common to evaluate the harmonic susceptibility of a system by evaluating its impedance vs. frequency characteristic. In Figure 14 impedance scans are given for the example system. Without a capacitor in the system the characteristic is nearly linear. With a capacitor a high impedance point occurs which is referred to as resonance. In this example it occurs near the fifth harmonic. A six pulse converter generates a large amount of fifth harmonic current so this would be a potential problem. The fifth harmonic voltage would be equal to the magnitude of the current times the impedance at that frequency. An example of the system voltage with significant fifth harmonic distortion and the associated capacitor bank current is illustrated in Figure 16. (Note that in a capacitor bank the percent harmonic current equals the harmonic number times the percent harmonic voltage.) A common remedy to the resonance problem is to design the capacitor bank as a filter tuned to near the fifth harmonic. The impedance scan shown in Figure 15 illustrates how the filter moves the resonance point to a lower frequency below the fifth harmonic where the 6-pulse converter does not generate any significant harmonics.

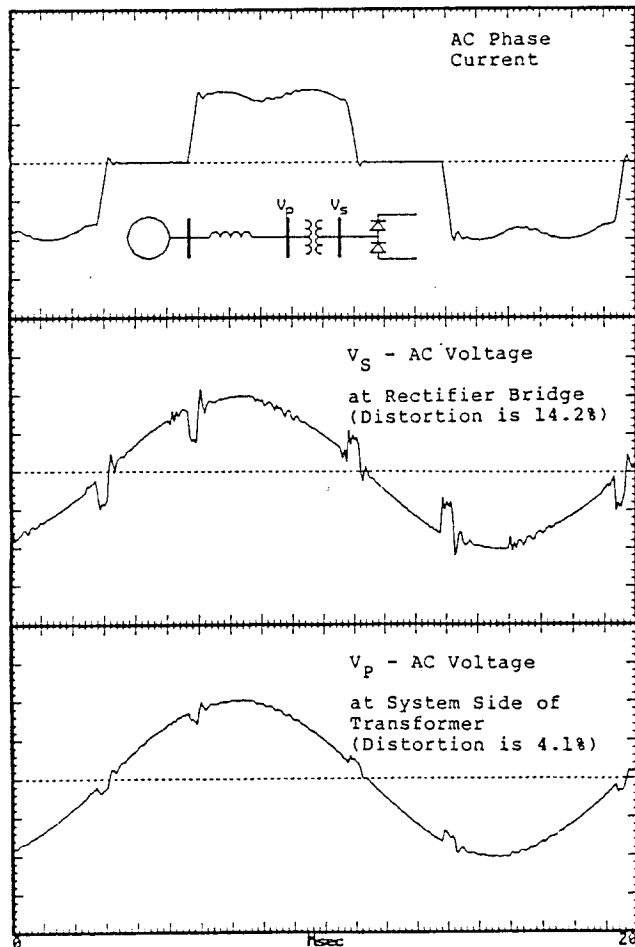

Fig. 9 Typical Waveforms for a 6-Pulse Converter

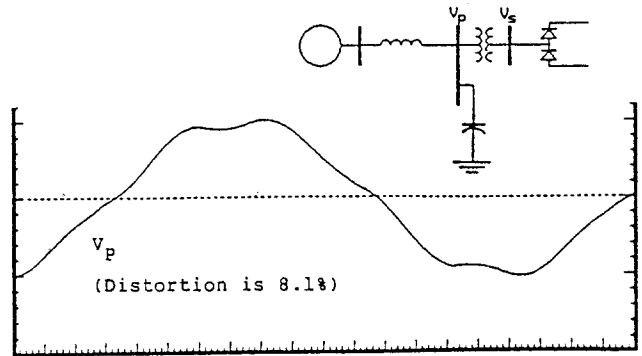

Fig. 10 Adding a Capacitor Bank

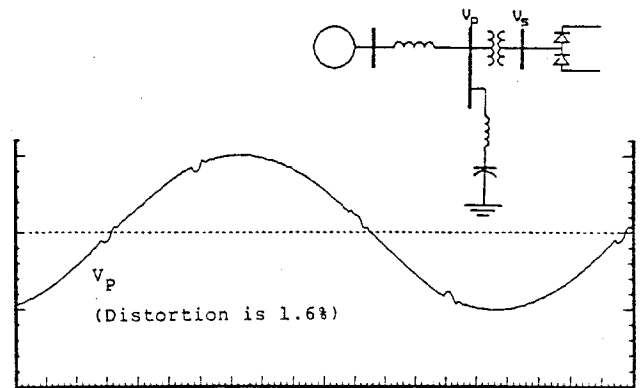

Fig. 11 Adding a Filter Capacitor Bank

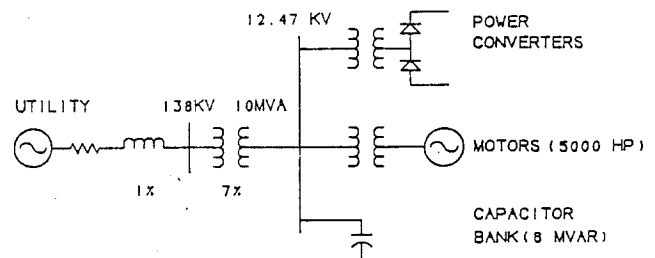

Fig. 12 Example System

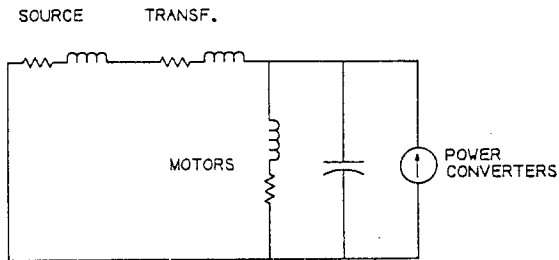

Fig. 13 Equivalent Circuit for Harmonic Calculations

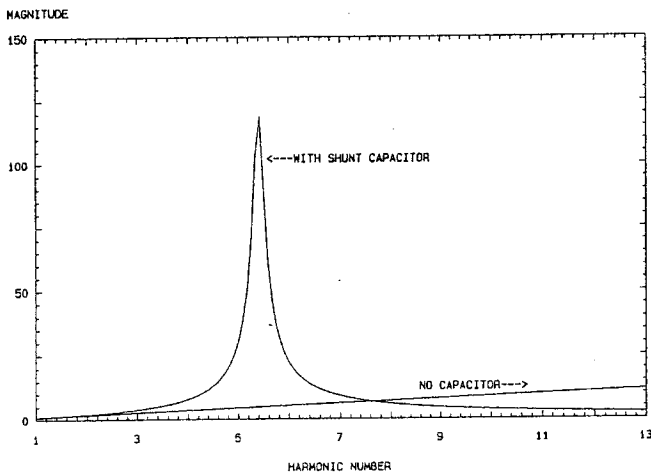

Fig. 14 System Impedance vs. Harmonic Number

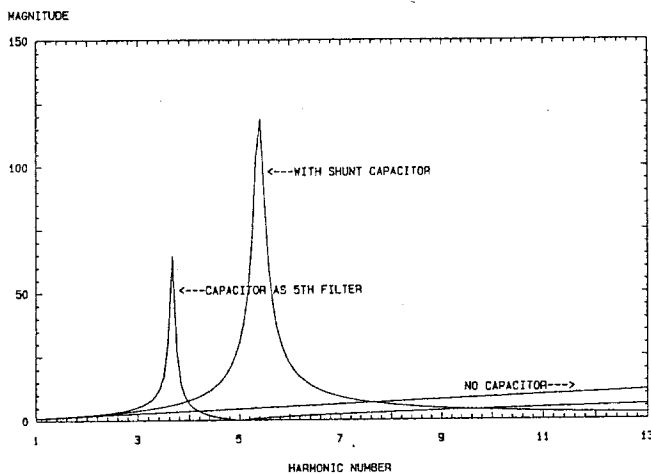

Fig. 15 System Impedance vs. Harmonic Number

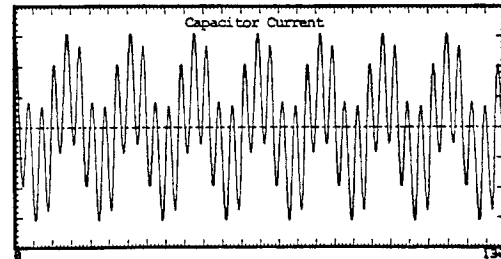
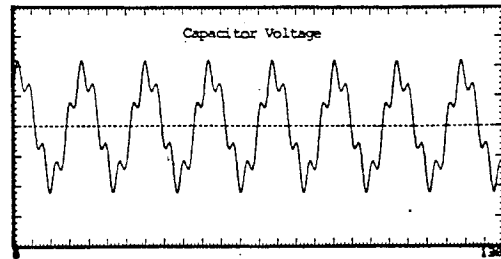

Fig. 16 Capacitor Bank Voltage and Current

Harmonic Standards

IEEE Std 519-1981, "IEEE Guide for Harmonic Control and Reactive Compensation of Static Power Converters", provides guidelines for harmonic voltage distortion limits. This document basically recommends a 5% voltage distortion limit for systems up to 69 kV and a limit of 1.5% at 115 kV and above. This document is currently under revision and it will likely contain limits on both the harmonic currents injected into the system and the resultant voltage distortion. Although it is still in a draft stage, the proposed voltage limits are given in Table 2 and the current limits in Table 3.[15]

Effect of the Interconnected System

The example discussed above which was illustrated by the impedance scan in Figure 14 applies to a system where there are no other capacitor banks. It is clear from the scan that capacitor banks can have a very significant effect on harmonic distortion. The question arises then: "What effect do other capacitor banks on the interconnected power system have on the distortion that an individual industrial user experiences?" Some simple example cases will illustrate the answer to this question:

- Case 1 - System illustrated in Figure 12
- Case 2 - Same as case 1 but has a 28 MVAR capacitor at the 138 kV bus.
- Case 3 - Same as case 2 but transformer impedance is 5.33% and source impedance is 2.67%.

In Figure 17 impedance scans for cases 1 and 2 are compared as seen at the 12.47 kV bus. The 138 kV capacitor has the effects of moving the major resonance frequency to a lower value and adding a second resonance frequency. The result is that there is a concern at both the fifth and seventh harmonics now.

In Figure 18 cases 1 and 3 are compared. The split in the impedance between the source and the transformer has a significant effect on where the resonance points occur compared to Case 2. Case 1 would indicate a problem at the fifth harmonic whereas the system corresponding to Case 3 would have a potential problem at the

seventh harmonic. The industrial system is the same in both, but the utility network, especially the capacitor banks, have resulted in a significant change in the harmonic evaluation.

For converting the 12.47 kV, 6 MVAR capacitor bank to a fifth harmonic filter, impedance scans of each of the three cases are given in Figure 19. In all cases the major peak is controlled to between the third and fourth harmonic where no major harmonic generation is expected. Cases 2 and 3 have a barely discernible peak at a high frequency due to the 28 MVAR capacitor bank.

The effect of the rest of the system on the harmonic condition for a given industrial user can be summarized as follows:

When applying a capacitor without tuning it as a filter, the other system capacitor banks can have a significant effect on the harmonic condition within the plant. The lower the ratio of the transformer impedance to the system short circuit impedance, the greater the effect of the system capacitance (including capacitor banks and lines). The farther the system capacitors are electrically from the industrial user the less effect they have.

When filters are applied the system capacitors have a much smaller effect. In many cases the effect may be negligible.

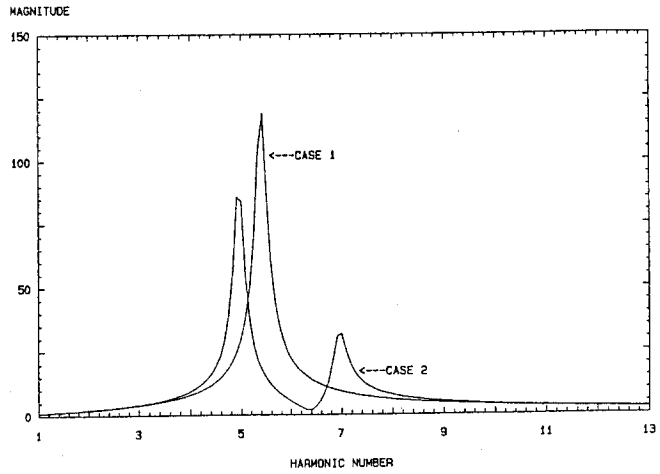

Fig. 17 System Impedance vs. Harmonic Number

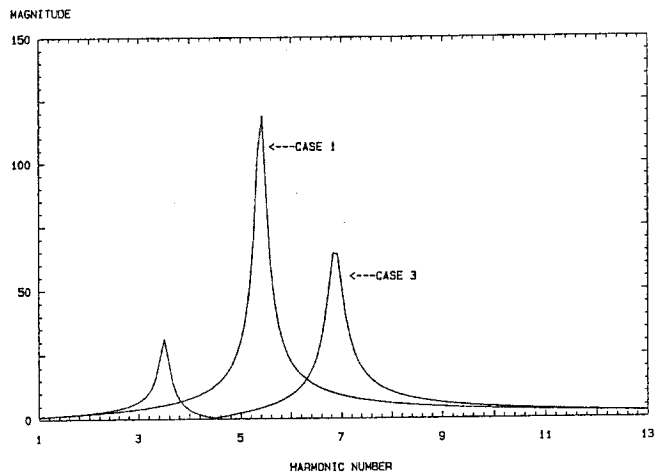

Fig. 18 System Impedance vs. Harmonic Number

Table 2
Proposed Harmonic Voltage Limits for Power Producers
(Public Utilities and Co-generators)

	Harmonic Voltage Distortion In % at PCC		
	2.3-69kV	>69-138kV	>138Kv
Maximum for Individual Harmonic	3.0	1.5	1.0
Total Harmonic Distortion	5.0	2.5	1.5

Table 3
Proposed Maximum Harmonic Current for Non-Linear Loads at the Point-Of-Common-Coupling, at Voltages of 2.4 to 69 kV.

Maximum Harmonic Current Distortion in % of Fundamental

I_{sc}/I_L	Harmonic Order (Odd Harmonics)					THD
	<11	11-15	17-21	23-33	35-up	
<20*	4.0	2.0	1.5	0.6	0.3	5.0
20-50	7.0	3.5	2.5	1.0	0.5	8.0
50-100	10.0	4.5	4.0	1.5	0.7	12.0
100-1000	12.0	5.5	5.0	2.0	1.0	15.0
>1000	15.0	7.0	6.0	2.5	1.4	20.0

Even harmonics are limited to 25% of the odd harmonic limits above.

*All power generation equipment is limited to these values of current distortion, regardless of actual I_{sc}/I_L .

Where I_{sc} = Maximum short circuit current at PCC.

and I_L = Maximum load Current (fundamental frequency) at PCC.

For PCC's from 69 to 138 kV, the limits are 50% of the limits above. A case-by-case evaluation is required for PCC's of 138 kV and above.

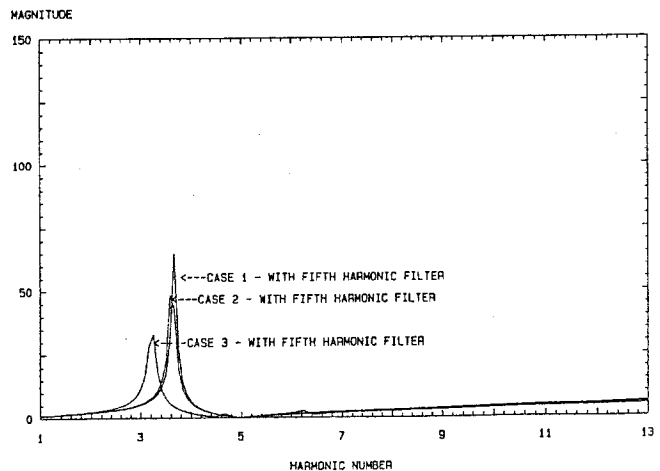

Fig. 19 System Impedance vs. Harmonic Number

Effect on the Interconnected System

As just discussed above the application of capacitors in one part of the system may be influenced by capacitors applied in another area when it comes to harmonic considerations. Conversely, the opposite is also true. Another case is used to illustrate that point:

Case 4 - Same as case 1 but a second identical industrial plant is located two miles down the line.

In Figure 20 impedance scans are shown for case 4 with a harmonic source at plant #1. These scans indicate that a significant harmonic source at plant #1 could cause a harmonic problem at plant #2 even though plant #2 has no harmonic sources itself.

In Figure 21 impedance scans for case 4 are repeated but with the capacitor bank in plant #1 converted to a fifth harmonic filter. Now the harmonic source at plant #1 has virtually no effect on plant #2.

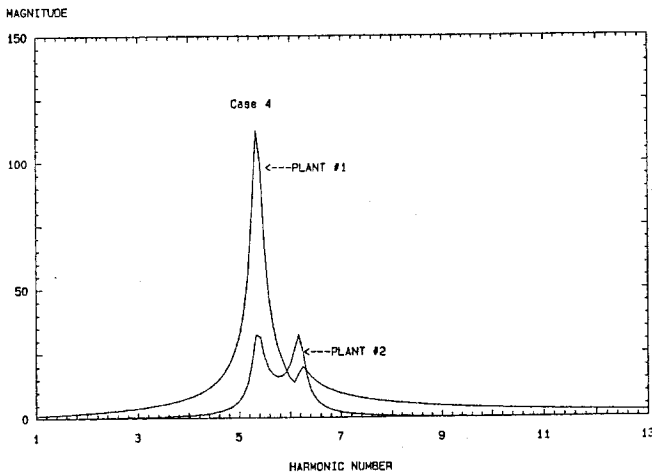

Fig. 20 System Impedance vs. Harmonic Number

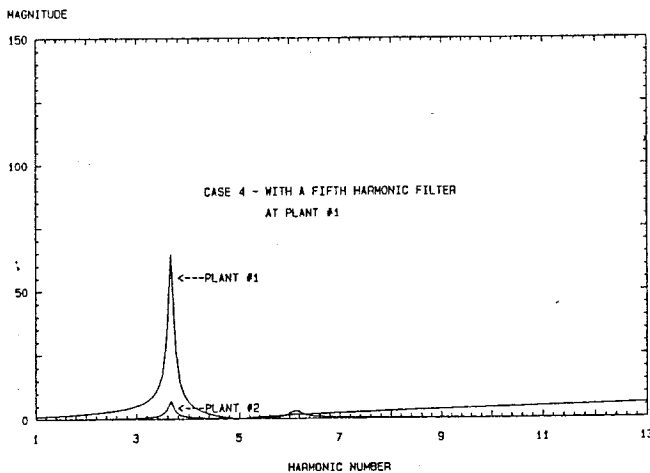

Fig. 21 System Impedance vs. Harmonic Number

DYNAMIC OVERVOLTAGES

The term dynamic overvoltages is used to describe a condition which is a combination of switching and harmonics. Energizing a transformer and a capacitor bank together can cause excessive dynamic overvoltages that affect the transformer, the capacitors, the fuses, and the arresters. It may be evidenced by capacitor failures and/or spurious fuse operations. An example waveform is shown in Figure 22. (This condition can also occur if the capacitor bank is already energized and a large transformer is being energized.)

The nature of the problem involves generation of high voltages due to the transformer inrush currents which are rich in harmonics by a system whose natural frequency is near one of these harmonics. Transformer inrush current includes significant magnitudes of harmonics of the fundamental frequency, i.e. second, third, fourth, fifth, etc. The highest magnitudes tend to occur for the lowest order harmonics. If the system equivalent impedance at one of more of those frequencies is high, then the voltage at the point will also be high. This tends to happen when a shunt capacitor bank or filter bank is applied, causing a parallel resonance with the system. The problem exhibits itself in the form of a long-term overvoltage, which has a high harmonic content, lasting for many cycles - even seconds.

Because arresters cannot effectively protect against steady-state or dynamic overvoltages, this type of switching is not recommended unless detailed studies show that the resulting overvoltages will not be excessive. This type of condition could inadvertently occur when a plant is being energized after an outage. The best procedure is generally to deenergize the capacitors, energize the transformer, and then reenergize the capacitors as the load requires it.

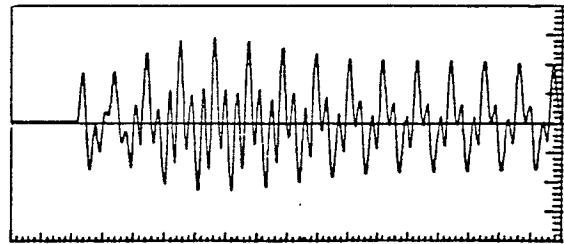

Fig. 22 Example of Dynamic Overvoltage

SUMMARY AND CONCLUSIONS

The discussions in this paper emphasized the following points:

1. Capacitor bank applications have increased significantly at all voltage levels over the past decade.
2. The switching of a capacitor bank can cause transient overvoltage concerns at other points in the system under certain conditions. These overvoltages can occur at the same voltage level and at lower voltage levels on the system. A number of methods are discussed for reducing these transients. These include closing and opening resistors, controlled closing, staggered closing, reactors, and surge arresters. In some cases, changing capacitor bank locations or sizes may be appropriate.
3. Capacitor banks throughout the system can influence the distortion level that occurs on the system due to a harmonic source. That effect can be minimized by using filter capacitor banks in the plant at the medium or low voltage buses which would be at or near the source of the harmonics.

REFERENCES

1. IEEE Working Group on Capacitance Current Switching, "Bibliography on Switching Of Capacitive Circuits Exclusive of Series Capacitors", IEEE Transactions, PAS, Vol. 89, No. 6, pp. 1203-1207, July/August 1970.
2. A.J. Schultz, J.B. Johnson, and N.R. Schultz, "Magnification of Switching Surges", IEEE Transactions, PAS, pp. 1418-1426, February, 1959.
3. E.W. Boehne and S.S. Low, "Shunt Capacitor Energization with Vacuum Interruptors-A Possible Source of Overvoltages", IEEE Transactions, PAS, Vol.88, No. 9, pp. 1424-1443, September, 1969.
4. H.M. Pflanz and G.N. Lester, "Control of Overvoltages on Energizing Capacitor Banks", IEEE Transactions, PAS, Vol. 92, No. 3, pp. 907-915, May/June, 1973.
5. T.M. McCauley, D.C. Pelfrey, W.C. Roettger, and C.E. Wood, "The Impact of Shunt Capacitor Installations on Power Circuit Breaker Applications," IEEE Transactions, PAS, Vol. 99, No. 6, pp. 2210-2222, Nov/Dec, 1980.
6. R.C. Degeneff, W.J. McNutt, W. Neugebauer, J. Panek, M.E. McCallum, and C.C. Honey, "Transformer Response to System Switching Voltages", IEEE Transactions, PAS, Vol. 101, No. 6, pp.1457-1470, June, 1982.
7. M.F. McGranaghan, W.E. Reid, S.W. Law, and D.W. Gresham, "Overvoltage Protection of Shunt Capacitor Banks using MOV Arresters", IEEE Transactions, PAS, Vol. 104, No. 8, pp. 2326-2336, August, 1984.
8. R.W. Alexander, "Synchronous Closing Control for Shunt Capacitor Banks", IEEE Transactions, PAS, Vol. 104, No. 9, pp. 2619-2626, September, 1985.
9. R.A. Jones and H.K. Fortson, "Consideration of Phase-to-Phase Surges in the Application of Capacitor Banks", IEEE Transactions on Power Delivery, Vol.1, pp. 240-244, July 1986.
10. S.S. Mikhail and M.F. McGranaghan, "Evaluation of Switching Concerns Associated with 345 kV Shunt Capacitor Applications", IEEE Transactions on Power Delivery, pp. 221-230, April 1986.
11. R.S. Bayless, J.D. Selman, D.E. Truax, W.E. Reid, "Capacitor Switching and Transformer Transients", IEEE Transactions on Power Delivery, Vol. 3, No. 1, pp. 349-357, January 1988..
12. K.L. Spurling, A.E. Poitras, M.F. McGranaghan, J.H. Shaw, "Analysis and Operating Experience for Back-to-Back 115 kV Capacitor Banks", IEEE Transactions on Power Delivery, pp. 1255-1263, Oct. 1987.
13. R.C. Dugan, R. Gabrick, J.C. Wright, K.W. Patten, "Validated Techniques for Modeling Shell-Form EHV Transformers", Presented at 1988 IEEE Summer Power Meeting.
14. W.E. Reid and K.J. Petrus, "Harmonics and Capacitors in the Power System", Presented at the Pacific Coast Electrical Association Engineering & Operating Conference, Los Angeles, California, March 19-20, 1985.
15. C.K. Duffey and R.P. Stratford, "Update of Harmonic Standard IEEE-519, IEEE Recommended Practices and Requirements for Harmonic Control in Electric Power Systems", IEEE Paper No. PCIC-88-7.

W. Edward Reid is Director, Analytical Studies with Qual-Tech Engineers, Inc. of Pittsburgh, PA. He has nearly 20 years of experience in electrical power system analysis, most of that being with McGraw-Edison Power Systems. This has included system design, insulation coordination, harmonic analysis, equipment application problems, and harmonic and transient field measurements. He has had extensive experience in series and shunt capacitor applications and is the Chairman of the IEEE Capacitor Subcommittee. He also is or has been a member of the IEEE Pulp and Paper Committee, Working Group on Transient Recovery Voltages, Harmonics Working Group, Transformer Task Force on External Clearance Requirements, Insulation Coordination Subcommittee, and Standards Coordinating Committee 22 on Power Quality. He has coauthored over 10 technical papers on the above topics and is a registered professional engineer.