

Surge Protection Of Arc Furnace Transformers

A typical arc furnace system is illustrated in Figure 1. The following outline gives a brief summary of the significant transient overvoltage conditions associated with an arc furnace transformer application and the different methods that are used for providing surge protection for the transformer.

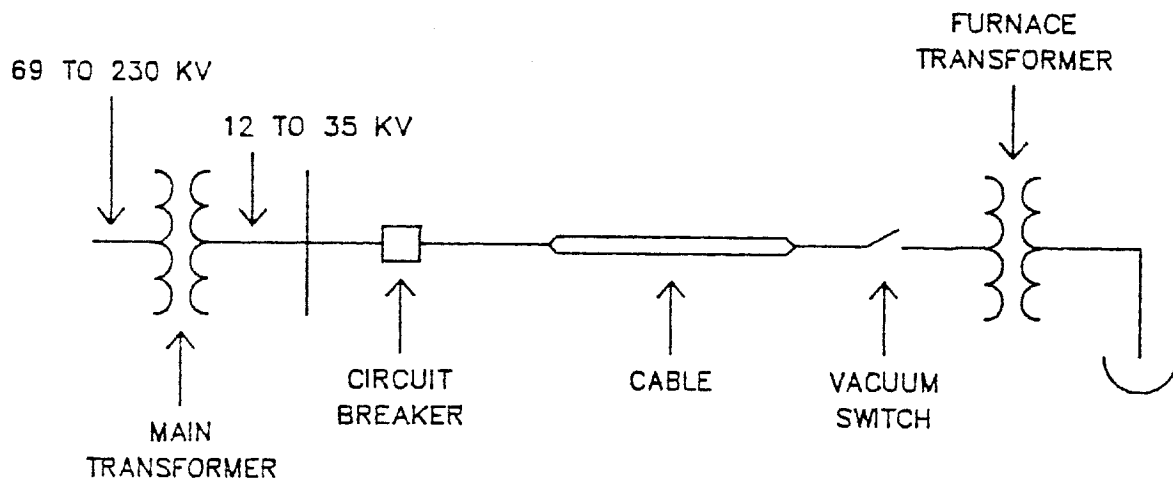

KEY CHARACTERISTICS

- 70% POWER FACTOR
- NONLINEAR LOAD
- FREQUENT SWITCHING OF TRANSFORMER (ON THE ORDER OF 50 TIMES/DAY)

Typical Arc Furnace System

Figure 1

1. Transient Overvoltage Conditions

A. *Current Chopping and Restriking*

When the vacuum switch or vacuum breaker is opened to deenergize the arc furnace transformer under no-load conditions with the electrodes raised, generally, a small chop of the load current occurs, as illustrated in Figure 2. Depending upon the transformer's inductance and capacitance characteristic, a transient will result at the transformer with a magnitude and frequency as illustrated in the simple circuit in Figure 2. The voltage that occurs is illustrated in Figure 2a. In this example waveform, the switch does not restrike. In Figure 2b, the voltage is illustrated for a multiple reignition or restrike condition. With the restrikes, significant fast front transients are impressed on the insulation of the transformer.

The potential for this fast front, high transient condition can be reduced by applying a surge capacitor on each phase of the transformer. This capacitor acts to reduce the frequency and the magnitude of the recovery voltage across the switch contacts and, therefore, to reduce the possibility of having any restrikes of the switch.

The application of an MOV arrester alone would reduce the high magnitude voltage stress to the transformer, but would not reduce the fast rate-of-rise that occurs on restrike. The use of both a surge capacitor and an MOV arrester provide the best protection for the arc furnace transformer. The negative aspect is that the system may now be prone to virtual current chopping and ferroresonance. If these two problems can be eliminated, surge capacitors can be beneficial.

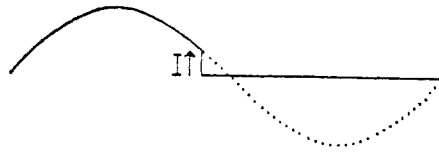
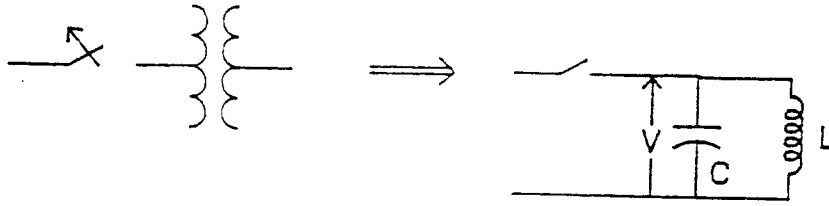

$$V = I \sqrt{\frac{L}{C}}$$

$$F = \frac{1}{2\pi\sqrt{LC}}$$

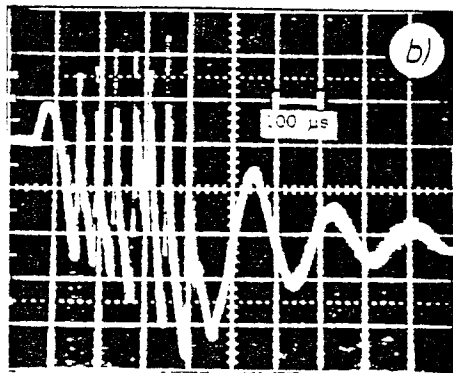
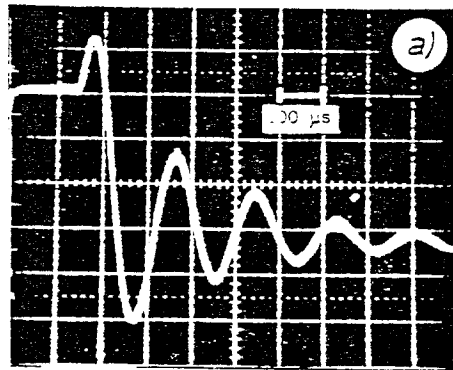

- a) with clean current chopping
- b) with re-strikes

Example Voltages Due To Current Chopping

Figure 2

B. *Virtual Current Chopping*

Virtual current chopping is possible in a circuit which has both a power factor capacitor bank and a surge capacitor. It can occur when the circuit is deenergized under load, i.e., the electrodes have not been raised from the molten steel. A restrike may occur if the rate-of-rise of the switch transient recovery voltage (TRV) is sufficiently high. The resulting surge could feed back into the other two phases through the surge capacitors superimposing a high-frequency current on the 60 Hz current. The high-frequency current could force an early current zero, making it appear similar to a current chop. The resulting voltages at the transformer are a function of the load current and the transformer leakage impedance. Surges may be large enough to cause arrester operation.

Virtual current chopping may be minimized by changing the circuit in one of the following ways:

1. Eliminate the surge capacitor and use an MOV arrester only.
2. Eliminate the power factor capacitor bank.
3. Apply the surge capacitor with an appropriate series resistor.
4. Apply the power factor capacitor with a series tuning reactor.

The series resistor adds enough damping in the ground circuit to prevent virtual current chopping from occurring, such that an early current zero cannot be attained. Harmonic tuning reactors in series with the power factor capacitor act in the same manner as series resistors with surge capacitors to dampen the current.

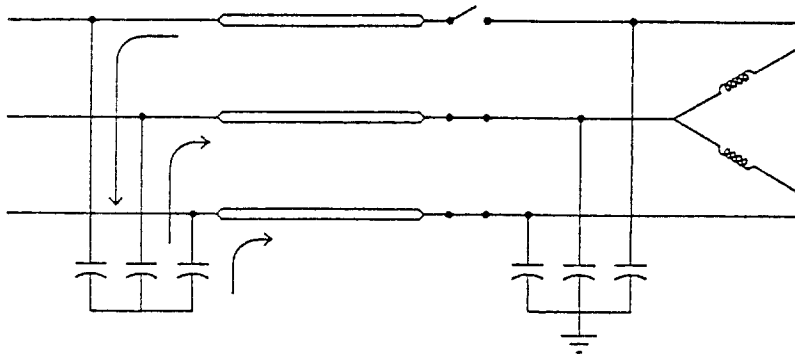

Virtual Current Chopping Circuit

Figure 3

C. Ferroresonance

Ferroresonance is a phenomenon associated with the condition of a capacitor in series with the nonlinear or saturable inductance of the arc furnace transformer. The surge capacitor and the primary connection of the transformer provide the circuit if the vacuum switch malfunctions. If the switching device malfunctions, causing one or two phases not to operate, a series path is provided with the transformer winding(s) and the surge capacitor(s). If the capacitance and inductance values are such that they can be resonant at the power frequency, excessive voltages and currents can appear across the transformer windings and at the capacitors on the unenergized phases.

Joslyn manufactures an accessory for their vacuum switch which detects a malfunction in operation and will open all phases instantaneously. Thus, if a pole should delay, the vacuum switch should open before potential ferroresonant voltages could cause damage.

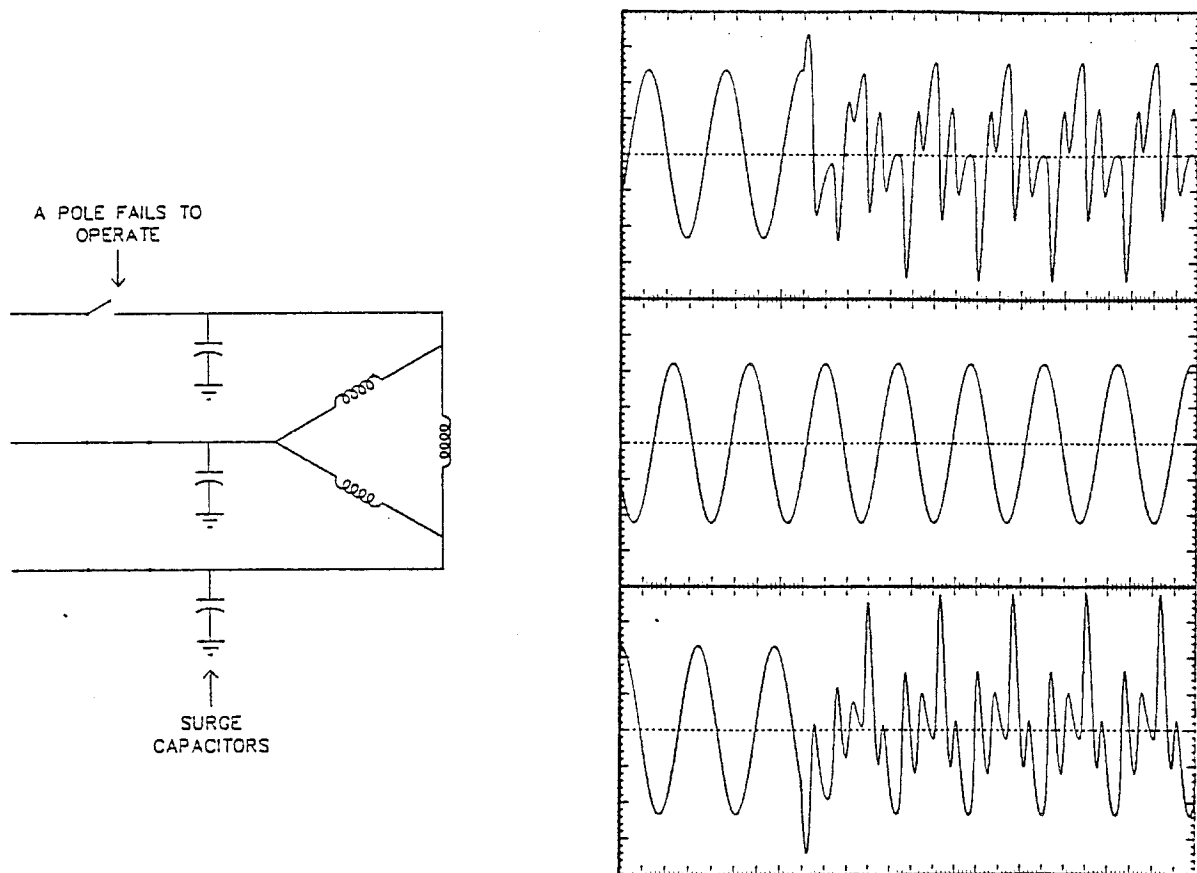

Example Voltages Due to Ferroresonance

Figure 4

D. *Internal Transformer Resonance*

Internal transformer resonance is possible for virtually any transformer. Arc furnace transformers generally have their first resonant frequency above 70 kHz. If a high transient of the appropriate frequency is generated on the power system, it could be amplified within the transformer, possibly causing an excessive overvoltage and an insulation failure. To accurately predict such transients requires attention to details of the circuit and knowledge of the internal impedance characteristic of the transformer. This detailed information is not normally available. However, an RC circuit at the transformer can significantly reduce these high frequency oscillations; and, thus, the possibility of internal resonance is greatly reduced.

2. Arc Furnace Transformer Overvoltage Protection Methods

Typical arc furnace overvoltage protection methods are illustrated in Figure 5. In some cases phase-to-phase surge arresters are also applied. Based upon the discussion given above, the advantages and disadvantages of each scheme are given in Table 1.

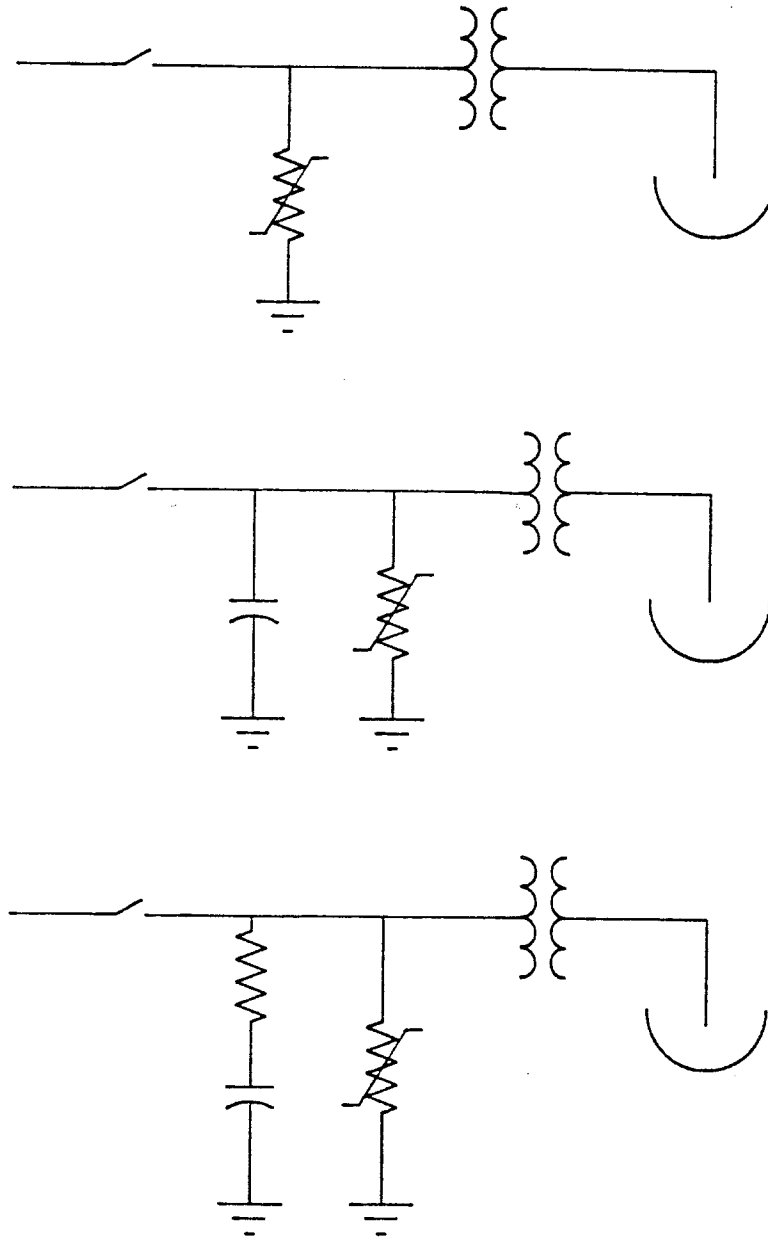

Arc Furnace Transformer Overvoltage Protection Methods

Figure 5

Table 1

Evaluation of Arc Furnace Transformer Overvoltage Protection Methods

Advantages

Disadvantages

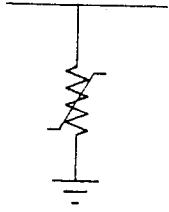

- Basic, Simple Overvoltage Protection
- Limits Peak Voltage

- Does Not Limit Rate-Of-Rise
- Large Number Of Repetitive Transients And Arrester Operations Due To Reignitions And Restrikes - Concern For Long Term Transformer Degradation And Internal Transformer Resonance

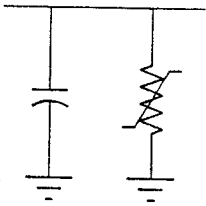

- Slows Down Transient
- Nearly Eliminates Restrikes And Repetitive Transients
- Arrester Operations Are Rare

- Potential For Ferroresonance If One Or Two Poles Of Switch Are Open
- Potential For Virtual Current Chopping If Large Capacitor Bank Is Nearby Without A Filter Reactor (Can Occur If Transformer Is Dropped Under Load)

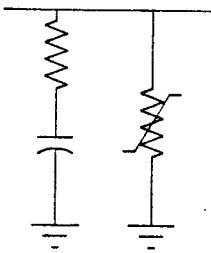

- Slows Down Transient
- Nearly Eliminates Restrikes And Repetitive Transients
- Arrester Operations Are Rare
- Minimizes Potential For Virtual Current Chopping
- Minimizes Potential For Internal Transformer Resonance

- Most Complex Protective Scheme
- Potential For Ferroresonance If One Or Two Poles Are Open
- If Resistor Burns Open, There Is No Surge Capacitor Protection